



## Features

- Industry Standard Architecture  
Emulates Many 20-Pin PALs®  
Low Cost Easy-to-Use Software Tools
- High Speed Electrically Erasable Programmable Logic Devices  
12 ns Maximum Pin-to-Pin Delay
- Low Power - 25  $\mu$ A Standby Power
- CMOS and TTL Compatible Inputs and Outputs  
Input and I/O Pin Keeper Circuits
- Advanced Flash Technology  
Reprogrammable  
100% Tested
- High Reliability CMOS Process  
20 Year Data Retention  
100 Erase/Write Cycles  
2,000V ESD Protection  
200 mA Latchup Immunity
- Commercial and Industrial Temperature Ranges
- Dual Inline and Surface Mount Packages in Standard Pinouts

High  
Performance  
E<sup>2</sup> PLD

ATF16V8CZ

## Block Diagram

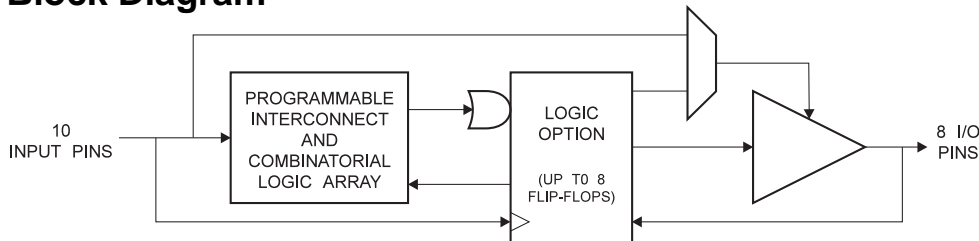

## Pin Configurations

Pin Name	Function
CLK	Clock
I	Logic Inputs
I/O	Bidirectional Buffers
$\overline{OE}$	Output Enable
VCC	+5V Supply

TSSOP Top View

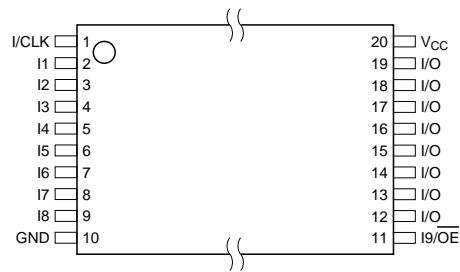

DIP/SOIC

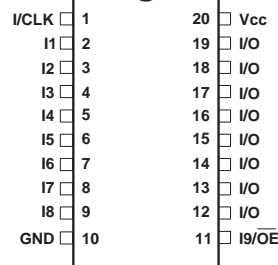

PLCC

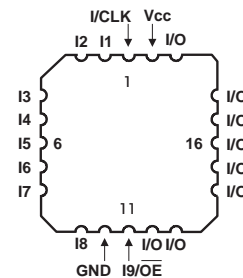

Top view





## Description (Continued)

The ATF16V8CZ is a high performance EECMOS Programmable Logic Device which utilizes Atmel's proven electrically erasable Flash memory technology. Speeds down to 12 ns and a 25  $\mu$ A edge-sensing power down mode are offered. All speed ranges are specified over the full  $5V \pm 10\%$  range for industrial temperature ranges;  $5V \pm 5\%$  for commercial range 5-volt devices.

The ATF16V8CZ incorporates a superset of the generic architectures, which allows direct replacement of the 16R8 family and most 20-pin combinatorial PLDs. Eight outputs are each allocated eight product terms. Three different

modes of operation, configured automatically with software, allow highly complex logic functions to be realized.

The ATF16V8CZ can significantly reduce total system power, thereby enhancing system reliability and reducing power supply costs. When all the inputs and internal nodes are not switching, supply current drops to less than 25  $\mu$ A. This automatic power down feature allows for power savings in slow clock systems and asynchronous applications. Also, the pin keeper circuits eliminate the need for internal pull-up resistors along with their attendant power consumption.

## Absolute Maximum Ratings\*

Temperature Under Bias.....	-40°C to +85°C
Storage Temperature.....	-65°C to +150°C
Voltage on Any Pin with Respect to Ground.....	-2.0V to +7.0V <sup>(1)</sup>
Voltage on Input Pins with Respect to Ground During Programming.....	-2.0V to +14.0V <sup>(1)</sup>
Programming Voltage with Respect to Ground.....	-2.0V to +14.0V <sup>(1)</sup>

\*NOTICE: Stresses beyond those listed under "Absolute Maximum Ratings" may cause permanent damage to the device. This is a stress rating only and functional operation of the device at these or any other conditions beyond those indicated in the operational sections of this specification is not implied. Exposure to absolute maximum rating conditions for extended periods may affect device reliability.

Note:

1. Minimum voltage is -0.6V dc, which may undershoot to -2.0V for pulses of less than 20 ns. Maximum output pin voltage is  $V_{cc} + 0.75V$  dc, which may overshoot to 7.0V for pulses of less than 20 ns.

## DC and AC Operating Conditions

	Commercial	Industrial
Operating Temperature (Case)	0°C - 70°C	-40°C - 85°C
V <sub>cc</sub> Power Supply	5V $\pm$ 5%	5V $\pm$ 10%

## DC Characteristics

Symbol	Parameter	Condition	Min	Typ	Max	Units
I <sub>IL</sub>	Input or I/O Low Leakage Current	$0 \leq V_{IN} \leq V_{IL}(MAX)$			-10	μA
I <sub>IH</sub>	Input or I/O High Leakage Current	$3.5 \leq V_{IN} \leq V_{CC}$			10	μA
I <sub>CC1</sub>	Power Supply Current	15 MHz, V <sub>CC</sub> = MAX, V <sub>IN</sub> = 0, V <sub>CC</sub> , Outputs Open	Com.		95	mA
			Ind.		105	mA
I <sub>CC</sub> (1)	Power Supply Current, Standby Mode	MHz, V <sub>CC</sub> = MAX, V <sub>IN</sub> = 0, V <sub>CC</sub> , Outputs Open	Com.	5	25	μA
			Ind.	5	50	μA
I <sub>OS</sub>	Output Short Circuit Current	V <sub>OUT</sub> = 0.5V; V <sub>CC</sub> = 5V; TA = 25°C			-150	mA
V <sub>IL</sub>	Input Low Voltage	MIN < V <sub>CC</sub> < MAX	-0.5		0.8	V
V <sub>IH</sub>	Input High Voltage		2.0		V <sub>CC</sub> + 1	V
V <sub>OL</sub>	Output Low Current	V <sub>CC</sub> = MIN; All Outputs I <sub>OL</sub> = -16 mA	Com., Ind.		0.5	V
V <sub>OH</sub>	Output High Current	V <sub>CC</sub> = MIN I <sub>OL</sub> = -3.2 mA		2.4		V
I <sub>OL</sub>	Output Low Current	V <sub>CC</sub> = MIN	Com.	24		mA
			Ind.	12		mA
I <sub>OH</sub>	Output High Current	V <sub>CC</sub> = MIN	Com., Ind.	4		mA

Note: 1. All I<sub>CC</sub> parameters measured with outputs open.

## AC Waveforms (1)

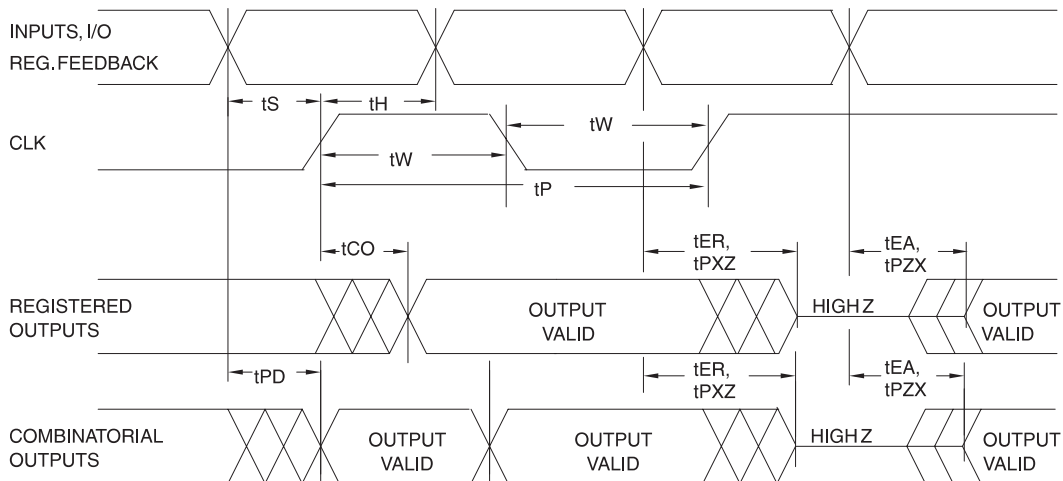

Note: 1. Timing measurement reference is 1.5V. Input AC driving levels are 0.0V and 3.0V, unless otherwise specified.

## AC Characteristics

Symbol	Parameter	-12		-15		Units
		Min	Max	Min	Max	
t <sub>PD</sub>	Input or Feedback to Non-Registered Output	3	12	3	15	ns
t <sub>CF</sub>	Clock to Feedback		6		8	ns
t <sub>CO</sub>	Clock to Output	2	8	2	10	ns
t <sub>S</sub>	Input or Feedback Setup Time	10		12		ns
t <sub>H</sub>	Input Hold Time	0		0		ns
t <sub>P</sub>	Clock Period	12		16		ns
t <sub>W</sub>	Clock Width	6		8		ns
F <sub>MAX</sub>	External Feedback 1/(t <sub>S</sub> + t <sub>CO</sub> )		55		45	MHz
	Internal Feedback 1/(t <sub>S</sub> + t <sub>CF</sub> )		62		50	MHz
	No Feedback 1/(t <sub>P</sub> )		83		62	MHz
t <sub>EA</sub>	Input to Output Enable — Product Term	3	12	3	15	ns
t <sub>ER</sub>	Input to Output Disable — Product Term	2	15	2	15	ns
t <sub>PZX</sub>	$\overline{OE}$ pin to Output Enable	2	12	2	15	ns
t <sub>PXZ</sub>	$\overline{OE}$ pin to Output Disable	1.5	12	1.5	15	ns

## Input Test Waveforms and Measurement Levels:

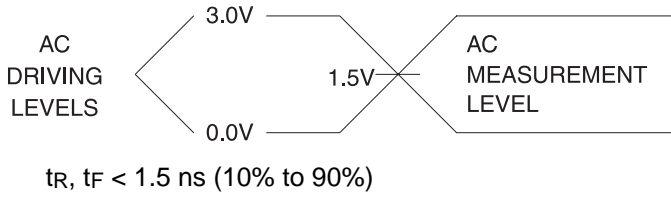

## Output Test Loads

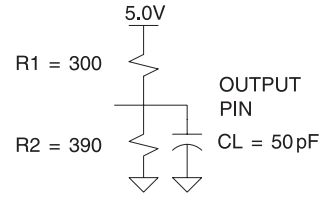

Note: Similar devices are tested with slightly different loads. These load differences may affect output signals' delay and slew rate. Atmel devices are tested with sufficient margins to meet compatible devices.

## Pin Capacitance ( $f = 1 \text{ MHz, } T = 25^\circ\text{C}$ ) <sup>(1)</sup>

	Typ	Max	Units	Conditions
C <sub>IN</sub>	5	8	pF	V <sub>IN</sub> = 0V
C <sub>OUT</sub>	6	8	pF	V <sub>OUT</sub> = 0V

Note: 1. Typical values for nominal supply voltage. This parameter is only sampled and is not 100% tested.

## Power Up Reset

The ATF16V8CZ's registers are designed to reset during power up. At a point delayed slightly from V<sub>CC</sub> crossing V<sub>RST</sub>, all registers will be reset to the low state. As a result, the registered output state will always be high on power-up.

This feature is critical for state machine initialization. However, due to the asynchronous nature of reset and the uncertainty of how V<sub>CC</sub> actually rises in the system, the following conditions are required:

- 1) The V<sub>CC</sub> rise must be monotonic, from below .7 volts,
- 2) After reset occurs, all input and feedback setup times must be met before driving the clock term high, and
- 3) The signals from which the clock is derived must remain stable during t<sub>PR</sub>.

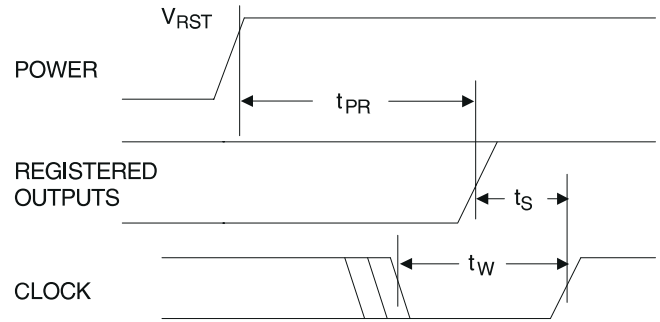

Parameter	Description	Typ	Max	Units
t <sub>PR</sub>	Power-Up Reset Time	600	1,000	ns
V <sub>RST</sub>	Power-Up Reset Voltage	3.8	4.5	V

## Registered Output Preload

The ATF16V8CZ's registers are provided with circuitry to allow loading of each register with either a high or a low. This feature will simplify testing since any state can be forced into the registers to control test sequencing. A JEDEC file with preload is generated when a source file with vectors is compiled. Once downloaded, the JEDEC file preload sequence will be done automatically by approved programmers.

## Input and I/O Pin Keeper Circuits

The ATF16V8CZ contains internal input and I/O pin keeper circuits. These circuits allow each ATF16V8CZ pin to hold its previous value even when it is not being driven by an external source or by the device's output buffer. This helps insure that all logic array inputs are at known, valid logic levels. This reduces system power by preventing pins from floating to indeterminate levels. By using pin keeper circuits rather than pull-up resistors, there is no DC

## Input Diagram

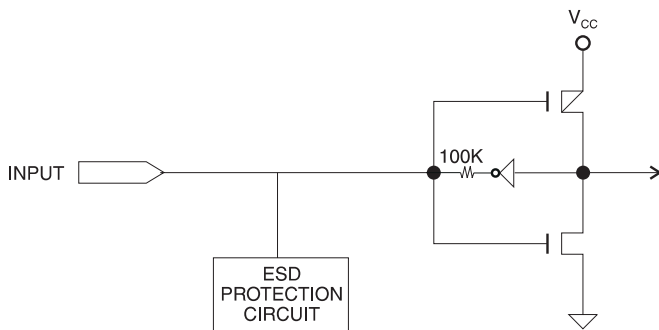

## Security Fuse Usage

A single fuse is provided to prevent unauthorized copying of the ATF16V8CZ fuse patterns. Once programmed, fuse verify and preload are inhibited. However, the 64-bit User Signature remains accessible.

The security fuse should be programmed last, as its effect is immediate.

current required to hold the pins in either logic state (high or low).

These pin keeper circuits are implemented as weak feedback inverters, as shown in the Input Diagram below. These keeper circuits can easily be overdriven by standard TTL- or CMOS-compatible drivers. The typical overdrive current required is 40  $\mu$ A.

## I/O Diagram

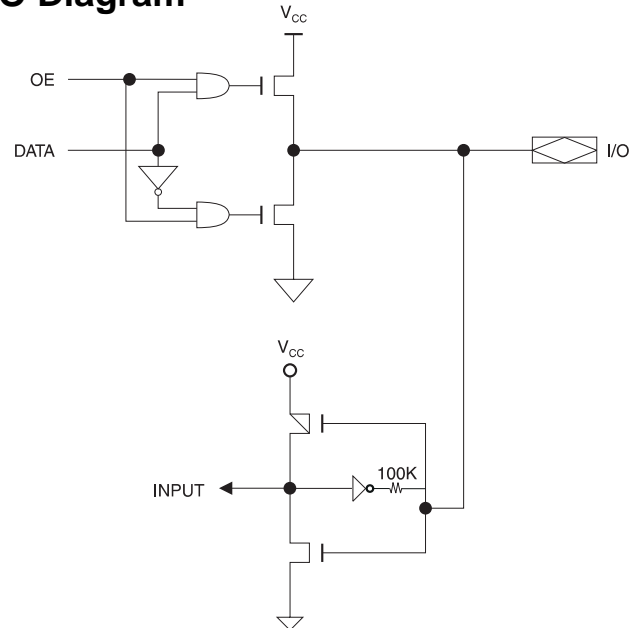

## Compiler Mode Selection

	Registered	Complex	Simple	Auto Select
ABEL, Atmel-ABEL	P16V8R	P16V8C	P16V8AS	P16V8
CUPL	G16V8MS	G16V8MA	G16V8AS	G16V8A
LOG/iC	GAL16V8_R <sup>(1)</sup>	GAL16V8_C7 <sup>(1)</sup>	GAL16V8_C8 <sup>(1)</sup>	GAL16V8
OrCAD-PLD	"Registered"	"Complex"	"Simple"	GAL16V8A
PLDesigner	P16V8R	P16V8C	P16V8C	P16V8A
Tango-PLD	G16V8R	G16V8C	G16V8AS	G16V8

Note: 1. Only applicable for version 3.4 or lower.

**SUPPLY CURRENT  
VS. INPUT FREQUENCY**  
ATF16V8CZ (VCC = 5V, TA = 25°C)

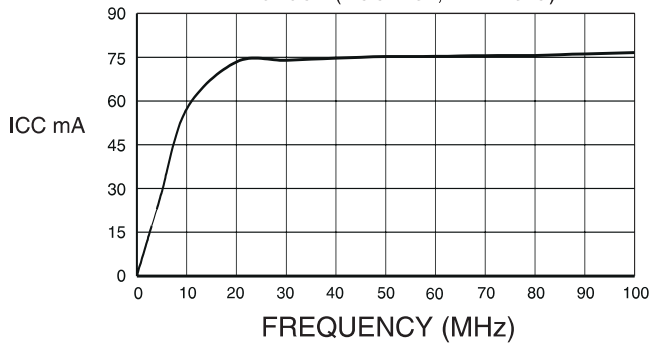

**NORMALIZED SUPPLY CURRENT  
VS. SUPPLY VOLTAGE**  
(TA = 25°C STANDBY)

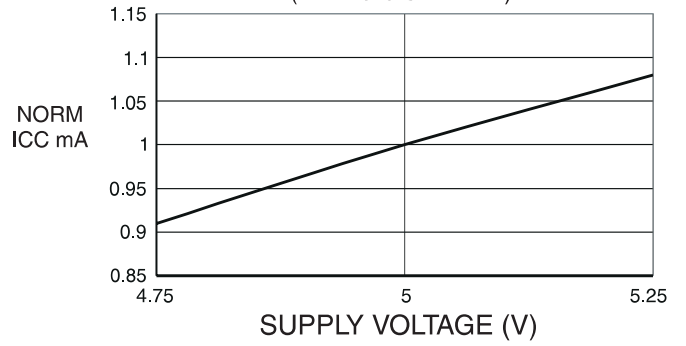

**NORMALIZED SUPPLY CURRENT  
VS. AMBIENT TEMPERATURE**  
(VCC = 5V STANDBY)

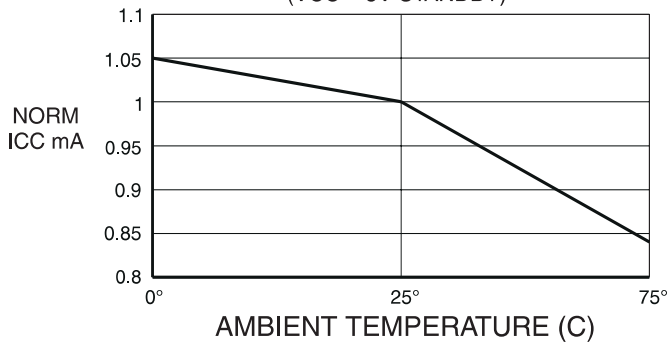

**OUTPUT SOURCE CURRENT  
VS. SUPPLY VOLTAGE** (VOH = 2.4V, TA = 25°C)

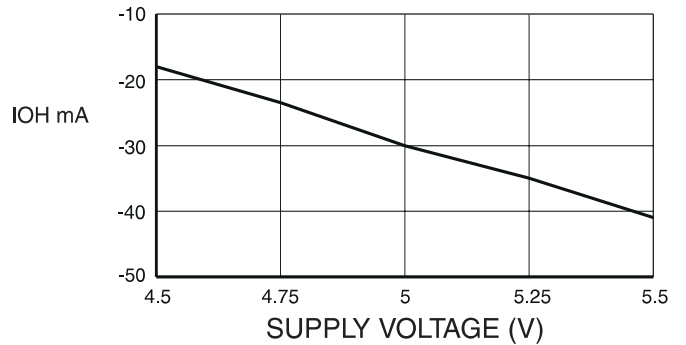

**OUTPUT SINK CURRENT  
VS. SUPPLY VOLTAGE** (TA = 25°C, VOL = 0.45V)

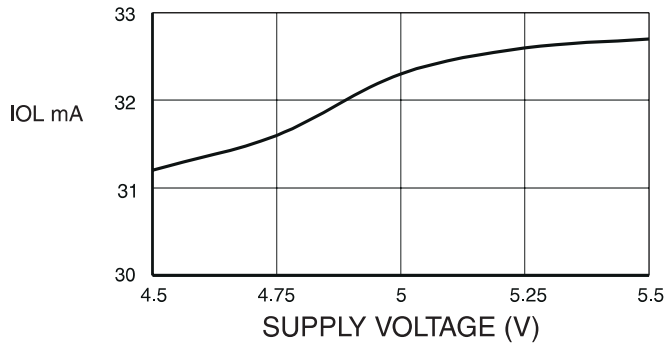

**OUTPUT SOURCE CURRENT  
VS. OUTPUT VOLTAGE** (VOH = 2.4V, TA = 25°C)

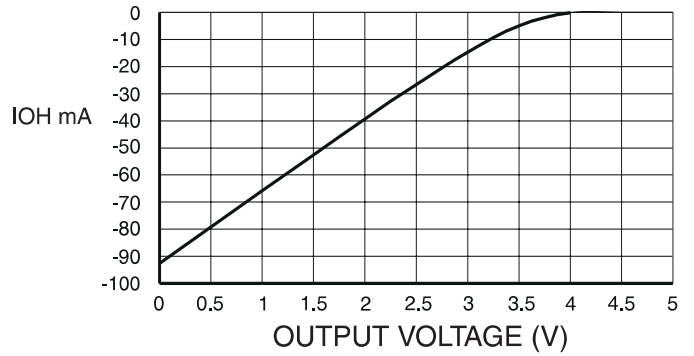

**OUTPUT SINK CURRENT  
VS. OUTPUT VOLTAGE** (VCC = 5V, TA = 25°C)

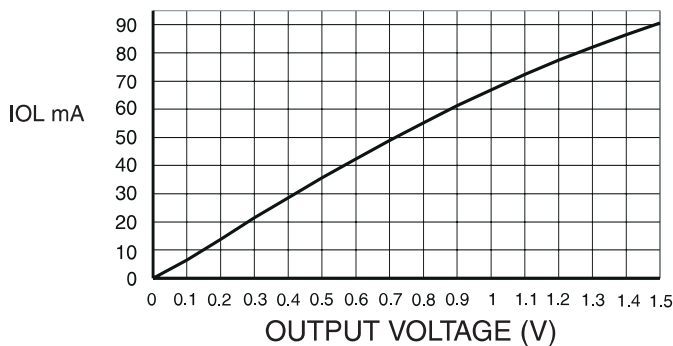

**NORMALIZED  $t_{PD}$   
VS. SUPPLY VOLTAGE** (TA = 25°C)

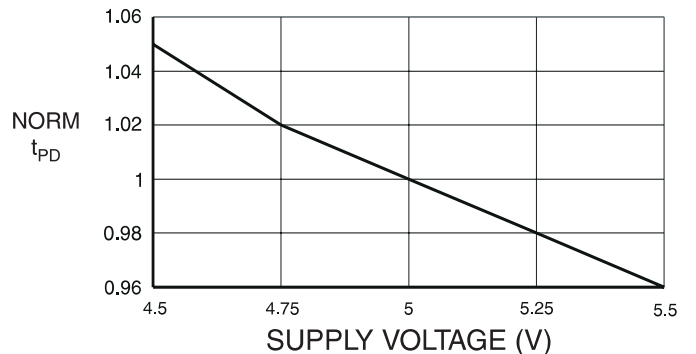

NORMALIZED  $t_{PD}$   
VS. AMBIENT TEMPERATURE (TA = 25°C)

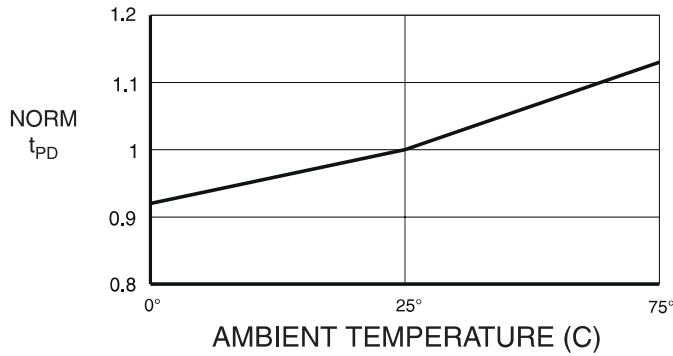

NORMALIZED  $t_{CO}$   
VS. SUPPLY VOLTAGE (TA = 25°C)

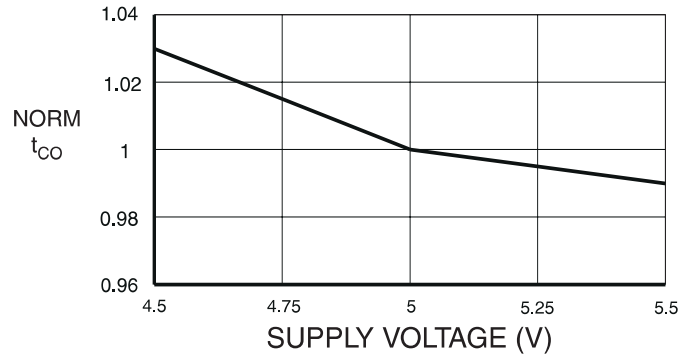

NORMALIZED  $t_{CO}$   
VS. AMBIENT TEMPERATURE (VCC = 5V)

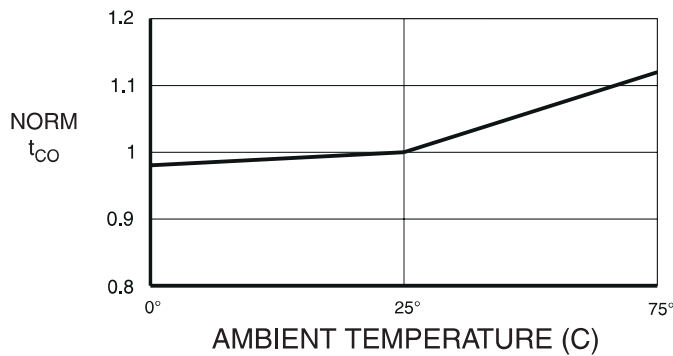

NORMALIZED  $t_S$   
VS. SUPPLY VOLTAGE (TA = 25°C)

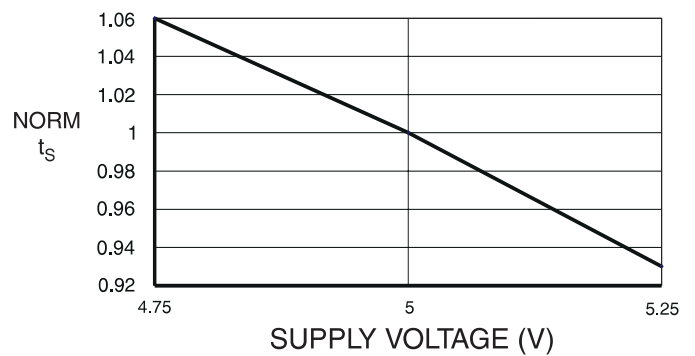

NORMALIZED  $t_S$   
VS. AMBIENT TEMPERATURE (TA = 25°C)

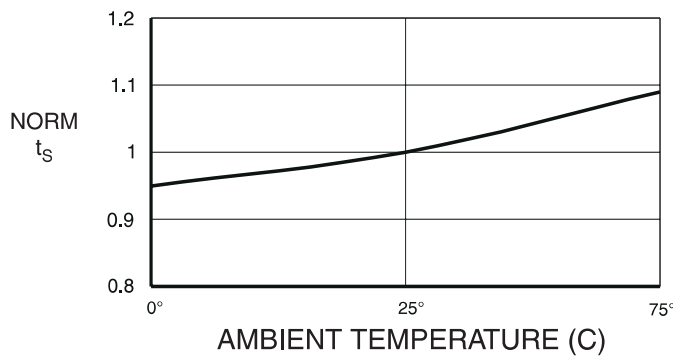

NORMALIZED  $t_H$   
VS. SUPPLY VOLTAGE (TA = 25°C)

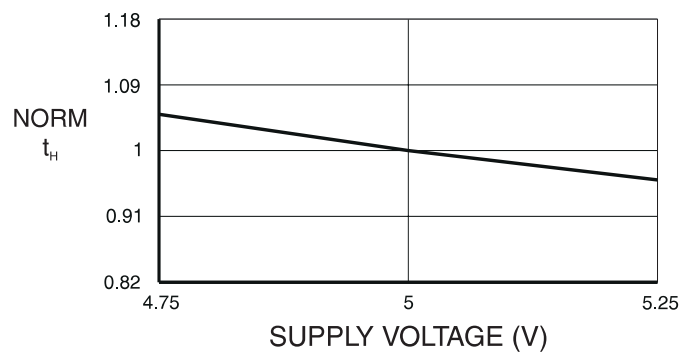

NORMALIZED  $t_H$   
VS. AMBIENT TEMPERATURE (VCC = 5V)

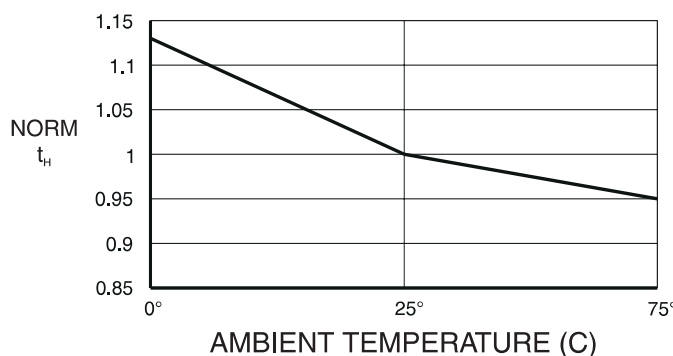

INPUT CLAMP CURRENT  
VS. INPUT VOLTAGE (TA = 25°C, VCC = 5V)

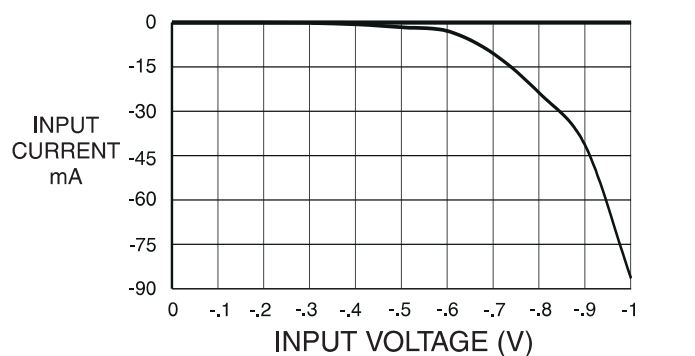



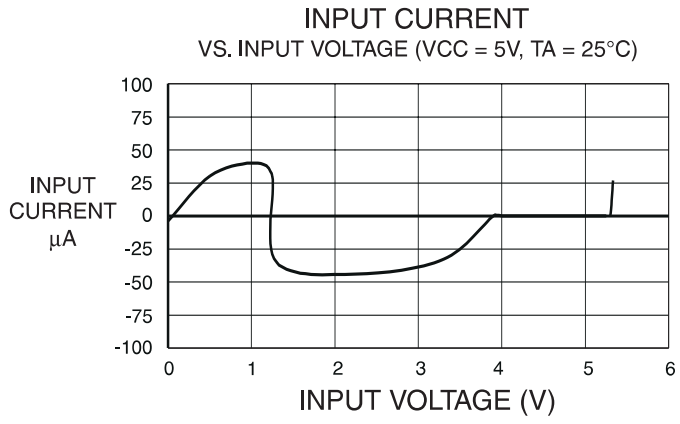



## Ordering Information

t <sub>PD</sub> (ns)	t <sub>s</sub> (ns)	t <sub>CO</sub> (ns)	Ordering Code	Package	Operation Range
12	10	8	ATF16V8CZ-12JC	20J	Commercial (0°C to 70°C)
			ATF16V8CZ-12PC	20P3	
			ATF16V8CZ-12SC	20S	
			ATF16V8CZ-12XC	20X	
15	12	10	ATF16V8CZ-15JC	20J	Commercial (0°C to 70°C)
			ATF16V8CZ-15PC	20P3	
			ATF16V8CZ-15SC	20S	
			ATF16V8CZ-15XC	20X	
	12	10	ATF16V8CZ-15JI	20J	Industrial (-40°C to 85°C)
			ATF16V8CZ-15PI	20P3	
			ATF16V8CZ-15SI	20S	
			ATF16V8CZ-15XI	20X	

Package Type	
<b>20J</b>	20-Lead, Plastic J-Leaded Chip Carrier (PLCC)
<b>20P3</b>	20-Lead, 0.300" Wide, Plastic Dual Inline Package (PDIP)
<b>20S</b>	20-Lead, 0.300" Wide, Plastic Gull Wing Small Outline (SOIC)
<b>20X</b>	20-Lead, 4.4 mm Wide, Plastic Thin Shrink Small Outline (TSSOP)