

8K x 8 Static RAM

Features

- **High speed**
— 15 ns
- **Fast t_{DOE}**
- **Low active power**
— 715 mW
- **Low standby power**
— 220 mW
- **CMOS for optimum speed/power**
- **Easy memory expansion with \overline{CE}_1 , CE_2 , and \overline{OE} features**
- **TTL-compatible inputs and outputs**
- **Automatic power-down when deselected**

Functional Description

The CY7C185 is a high-performance CMOS static RAM organized as 8192 words by 8 bits. Easy memory expansion is

provided by an active LOW chip enable (\overline{CE}_1), an active HIGH chip enable (CE_2), and active LOW output enable (\overline{OE}) and three-state drivers. This device has an automatic power-down feature (\overline{CE}_1 or CE_2), reducing the power consumption by 70% when deselected. The CY7C185 is in a standard 300-mil-wide DIP, SOJ, or SOIC package.

An active LOW write enable signal (\overline{WE}) controls the writing/reading operation of the memory. When \overline{CE}_1 and \overline{WE} inputs are both LOW and CE_2 is HIGH, data on the eight data input/output pins (I/O_0 through I/O_7) is written into the memory location addressed by the address present on the address pins (A_0 through A_{12}). Reading the device is accomplished by selecting the device and enabling the outputs, \overline{CE}_1 and \overline{OE} active LOW, CE_2 active HIGH, while \overline{WE} remains inactive or HIGH. Under these conditions, the contents of the location addressed by the information on address pins are present on the eight data input/output pins.

The input/output pins remain in a high-impedance state unless the chip is selected, outputs are enabled, and write enable (\overline{WE}) is HIGH. A die coat is used to insure alpha immunity.

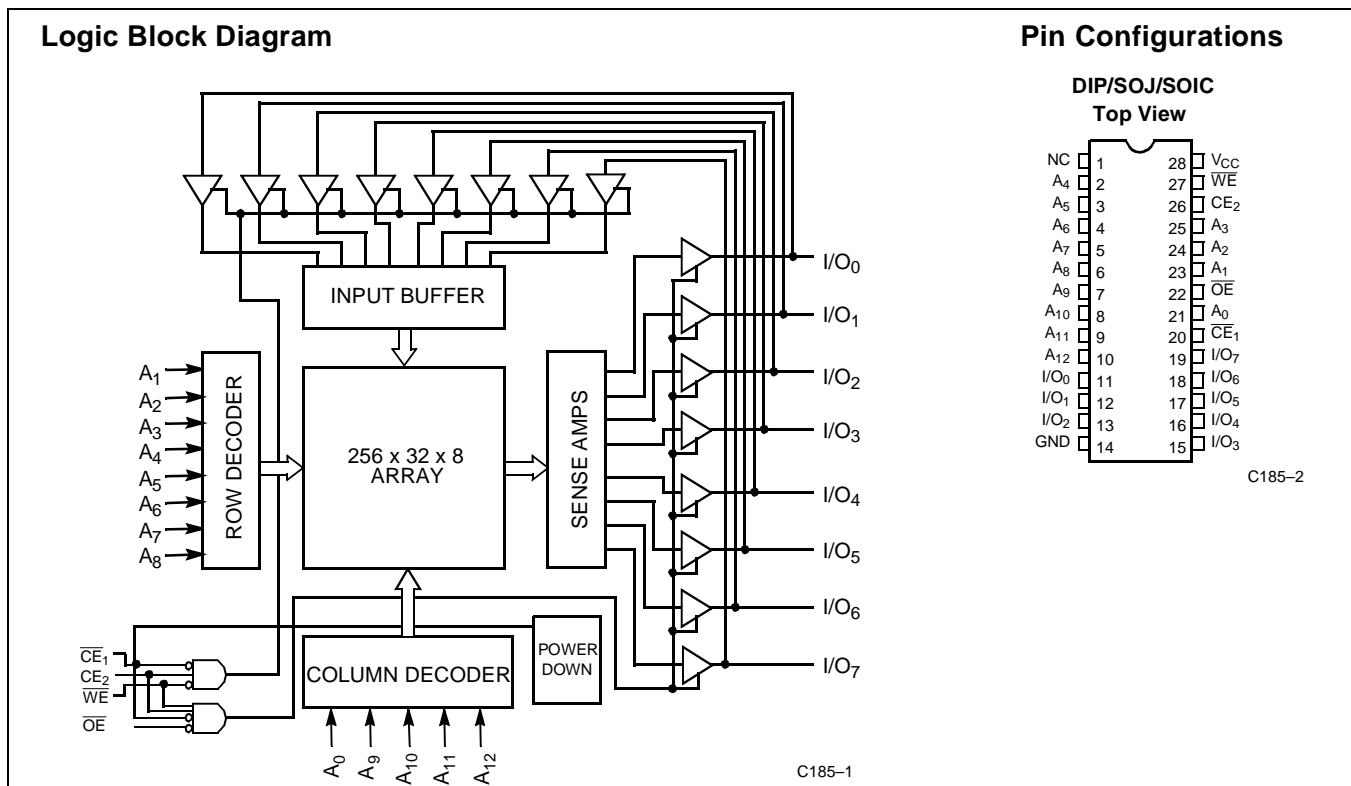

Selection Guide^[1]

	7C185-15	7C185-20	7C185-25	7C185-35
Maximum Access Time (ns)	15	20	25	35
Maximum Operating Current (mA)	130	110	100	100
Maximum Standby Current (mA)	40/15	20/15	20/15	20/15

Note:

1. For military specifications, see the CY7C185A datasheet.

Maximum Ratings

(Above which the useful life may be impaired. For user guidelines, not tested.)

Storage Temperature -65°C to +150°C
 Ambient Temperature with
 Power Applied..... -55°C to +125°C
 Supply Voltage to Ground Potential -0.5V to +7.0V
 DC Voltage Applied to Outputs
 in High Z State^[2] -0.5V to +7.0V
 DC Input Voltage^[2]..... -0.5V to +7.0V

Output Current into Outputs (LOW)..... 20 mA
 Static Discharge Voltage >2001V
 (per MIL-STD-883, Method 3015)
 Latch-Up Current..... >200 mA

Operating Range

Range	Ambient Temperature	V _{CC}
Commercial	0°C to +70°C	5V ± 10%
Industrial	-40°C to +85°C	5V ± 10%

Electrical Characteristics Over the Operating Range

Parameter	Description	Test Conditions	7C185-15		7C185-20		Unit
			Min.	Max.	Min.	Max.	
V _{OH}	Output HIGH Voltage	V _{CC} = Min., I _{OH} = -4.0 mA	2.4		2.4		V
V _{OL}	Output LOW Voltage	V _{CC} = Min., I _{OL} = 8.0 mA		0.4		0.4	V
V _{IH}	Input HIGH Voltage		2.2	V _{CC} + 0.3V	2.2	V _{CC} + 0.3V	V
V _{IL}	Input LOW Voltage ^[2]		-0.5	0.8	-0.5	0.8	V
I _{IX}	Input Load Current	GND ≤ V _I ≤ V _{CC}	-5	+5	-5	+5	μA
I _{OZ}	Output Leakage Current	GND ≤ V _I ≤ V _{CC} , Output Disabled	-5	+5	-5	+5	μA
I _{OS}	Output Short Circuit Current ^[3]	V _{CC} = Max., V _{OUT} = GND		-300		-300	mA
I _{CC}	V _{CC} Operating Supply Current	V _{CC} = Max., I _{OUT} = 0 mA		130		110	mA
I _{SB1}	Automatic Power-Down Current	Max. V _{CC} , $\overline{CE}_1 \geq V_{IH}$ or CE ₂ ≤ V _{IL} Min. Duty Cycle= 100%	40		20		mA
I _{SB2}	Automatic Power-Down Current	Max. V _{CC} , $\overline{CE}_1 \geq V_{CC} - 0.3V$, or CE ₂ ≤ 0.3V V _{IN} ≥ V _{CC} - 0.3V or V _{IN} ≤ 0.3V	15		15		mA

Notes:

- Minimum voltage is equal to -3.0V for pulse durations less than 30 ns.
- Not more than 1 output should be shorted at one time. Duration of the short circuit should not exceed 30 seconds.

Electrical Characteristics Over the Operating Range (continued)

Parameter	Description	Test Conditions	7C185-25		7C185-35		Unit
			Min.	Max.	Min.	Max.	
V _{OH}	Output HIGH Voltage	V _{CC} = Min., I _{OH} = -4.0 mA	2.4		2.4		V
V _{OL}	Output LOW Voltage	V _{CC} = Min., I _{OL} = 8.0 mA		0.4		0.4	V
V _{IH}	Input HIGH Voltage		2.2	V _{CC} + 0.3V	2.2	V _{CC} + 0.3V	V
V _{IL}	Input LOW Voltage ^[2]		-0.5	0.8	-0.5	0.8	V
I _{IX}	Input Load Current	GND ≤ V _I ≤ V _{CC}	-5	+5	-5	+5	μA
I _{oZ}	Output Leakage Current	GND ≤ V _I ≤ V _{CC} , Output Disabled	-5	+5	-5	+5	μA
I _{OS}	Output Short Circuit Current ^[3]	V _{CC} = Max., V _{OUT} = GND		-300		-300	mA
I _{CC}	V _{CC} Operating Supply Current	V _{CC} = Max., I _{OUT} = 0 mA		100		100	mA
I _{SB1}	Automatic Power-Down Current	Max. V _{CC} , $\overline{CE}_1 \geq V_{IH}$ or CE ₂ ≤ V _{IL} Min. Duty Cycle=100%		20		20	mA
I _{SB2}	Automatic Power-Down Current	Max. V _{CC} , $\overline{CE}_1 \geq V_{CC} - 0.3V$ or CE ₂ ≤ 0.3V V _{IN} ≥ V _{CC} - 0.3V or V _{IN} ≤ 0.3V		15		15	mA

Capacitance^[4]

Parameter	Description	Test Conditions	Max.	Unit
C _{IN}	Input Capacitance	T _A = 25°C, f = 1 MHz, V _{CC} = 5.0V	7	pF
C _{OUT}	Output Capacitance		7	pF

Note:

4. Tested initially and after any design or process changes that may affect these parameters.

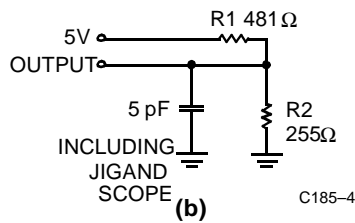
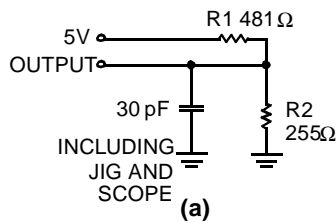
AC Test Loads and Waveforms

C185-4

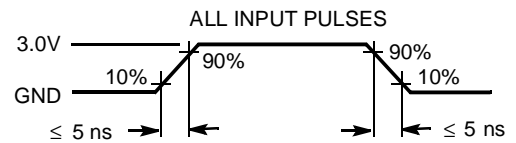

C185-5

Equivalent to: THÉVENIN EQUIVALENT

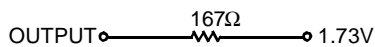

Switching Characteristics Over the Operating Range^[5]

Parameter	Description	7C185-15		7C185-20		7C185-25		7C185-35		Unit
		Min.	Max.	Min.	Max.	Min.	Max.	Min.	Max.	
READ CYCLE										
t _{RC}	Read Cycle Time	15		20		25		35		ns
t _{AA}	Address to Data Valid		15		20		25		35	ns
t _{OHA}	Data Hold from Address Change	3		5		5		5		ns
t _{ACE1}	\overline{CE}_1 LOW to Data Valid		15		20		25		35	ns
t _{ACE2}	CE ₂ HIGH to Data Valid		15		20		25		35	ns
t _{DOE}	\overline{OE} LOW to Data Valid		8		9		12		15	ns
t _{LZOE}	\overline{OE} LOW to Low Z	3		3		3		3		ns
t _{HZOE}	\overline{OE} HIGH to High Z ^[6]		7		8		10		10	ns
t _{LZCE1}	\overline{CE}_1 LOW to Low Z ^[7]	3		5		5		5		ns
t _{LZCE2}	CE ₂ HIGH to Low Z	3		3		3		3		ns
t _{HZCE}	\overline{CE}_1 HIGH to High Z ^[6, 7] CE ₂ LOW to High Z		7		8		10		10	ns
t _{PU}	\overline{CE}_1 LOW to Power-Up CE ₂ to HIGH to Power-Up	0		0		0		0		ns
t _{PD}	\overline{CE}_1 HIGH to Power-Down CE ₂ LOW to Power-Down		15		20		20		20	ns
WRITE CYCLE^[8]										
t _{WC}	Write Cycle Time	15		20		25		35		ns
t _{SCE1}	\overline{CE}_1 LOW to Write End	12		15		20		20		ns
t _{SCE2}	CE ₂ HIGH to Write End	12		15		20		20		ns
t _{AW}	Address Set-Up to Write End	12		15		20		25		ns
t _{HA}	Address Hold from Write End	0		0		0		0		ns
t _{SA}	Address Set-Up to Write Start	0		0		0		0		ns
t _{PWE}	\overline{WE} Pulse Width	12		15		15		20		ns
t _{SD}	Data Set-Up to Write End	8		10		10		12		ns
t _{HD}	Data Hold from Write End	0		0		0		0		ns
t _{HZWE}	\overline{WE} LOW to High Z ^[6]		7		7		7		8	ns
t _{LZWE}	\overline{WE} HIGH to Low Z	3		5		5		5		ns

Notes:

- Test conditions assume signal transition time of 5 ns or less, timing reference levels of 1.5V, input pulse levels of 0 to 3.0V, and output loading of the specified I_{OL}/I_{OH} and 30-pF load capacitance.
- t_{HZOE}, t_{HZCE}, and t_{HZWE} are specified with C_L = 5 pF as in part (b) of AC Test Loads. Transition is measured ±500 mV from steady state voltage.
- At any given temperature and voltage condition, t_{HZCE} is less than t_{LZCE1} and t_{LZCE2} for any given device.
- The internal write time of the memory is defined by the overlap of CE₁ LOW, CE₂ HIGH, and WE LOW. All 3 signals must be active to initiate a write and either signal can terminate a write by going HIGH. The data input set-up and hold timing should be referenced to the rising edge of the signal that terminates the write.

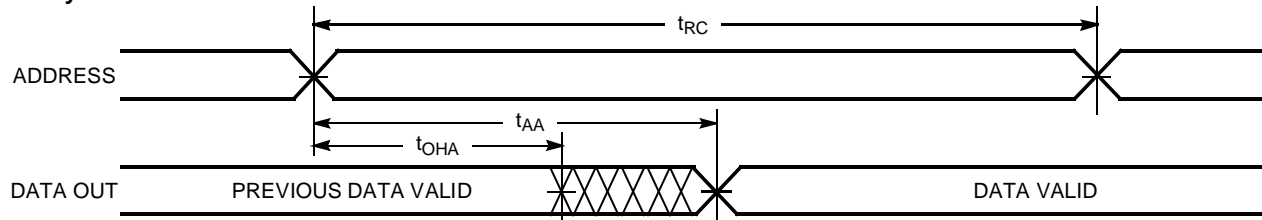
Switching Waveforms
Read Cycle No.1^[9,10]

C185-6

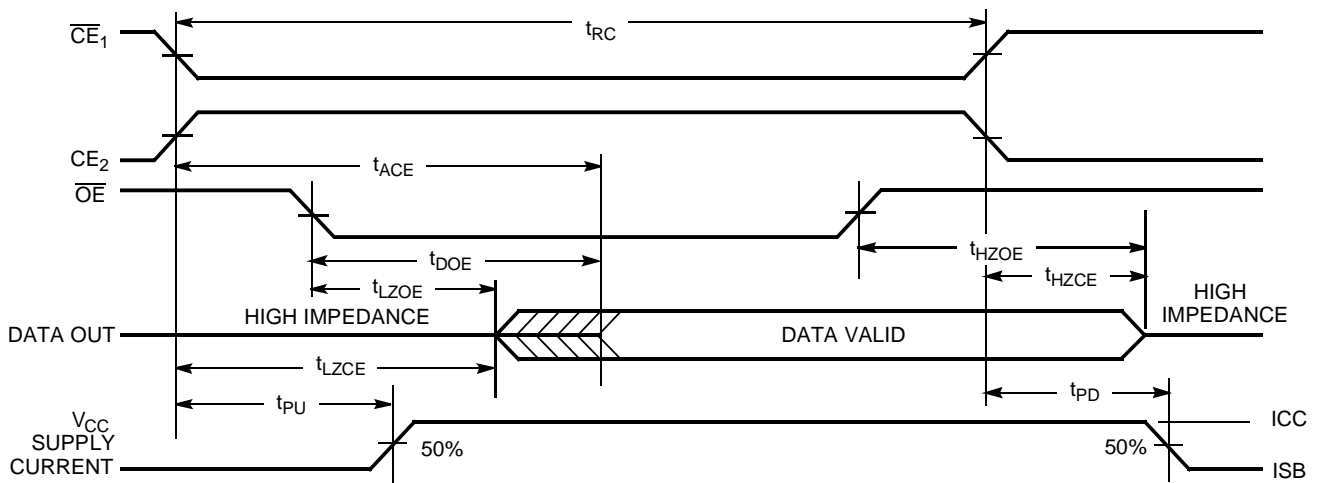
Read Cycle No.2^[11,12]

C185-7

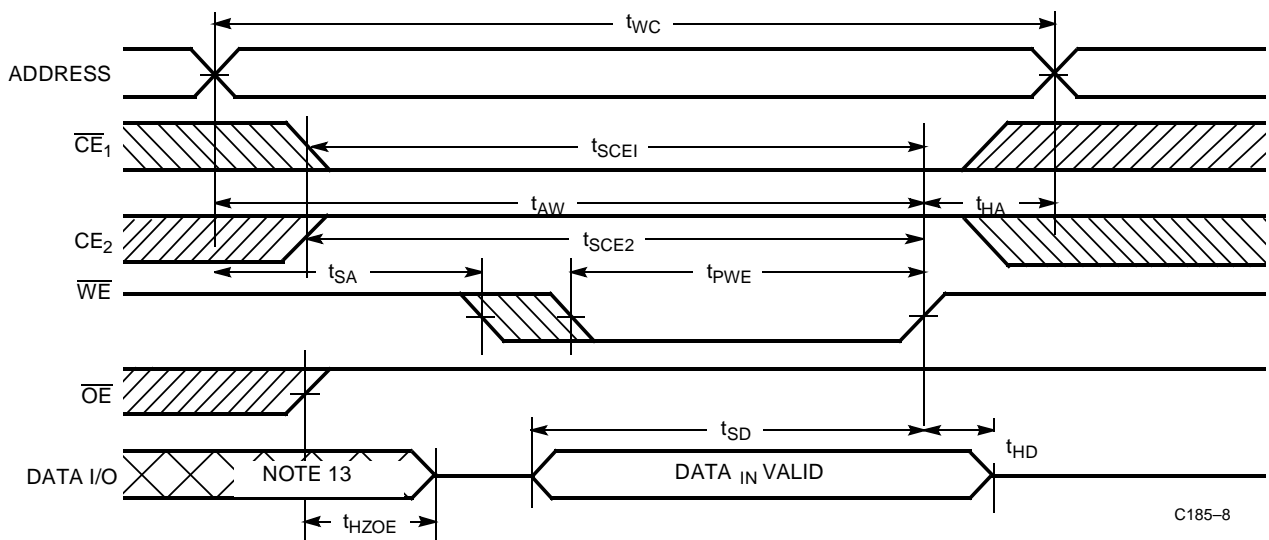
Write Cycle No. 1 (\overline{WE} Controlled)^[10,12]

C185-8

 9. Device is continuously selected. \overline{OE} , $\overline{CE}_1 = V_{IL}$. $CE_2 = V_{IH}$.

 10. \overline{WE} is HIGH for read cycle.

 11. Data I/O is High Z if $\overline{OE} = V_{IH}$, $\overline{CE}_1 = V_{IH}$, $\overline{WE} = V_{IL}$, or $CE_2 = V_{IL}$.

 12. The internal write time of the memory is defined by the overlap of \overline{CE}_1 LOW, CE_2 HIGH and \overline{WE} LOW. \overline{CE}_1 and \overline{WE} must be LOW and CE_2 must be HIGH to initiate write. A write can be terminated by \overline{CE}_1 or \overline{WE} going HIGH or CE_2 going LOW. The data input set-up and hold timing should be referenced to the rising edge of the signal that terminates the write.

13. During this period, the I/Os are in the output state and input signals should not be applied.

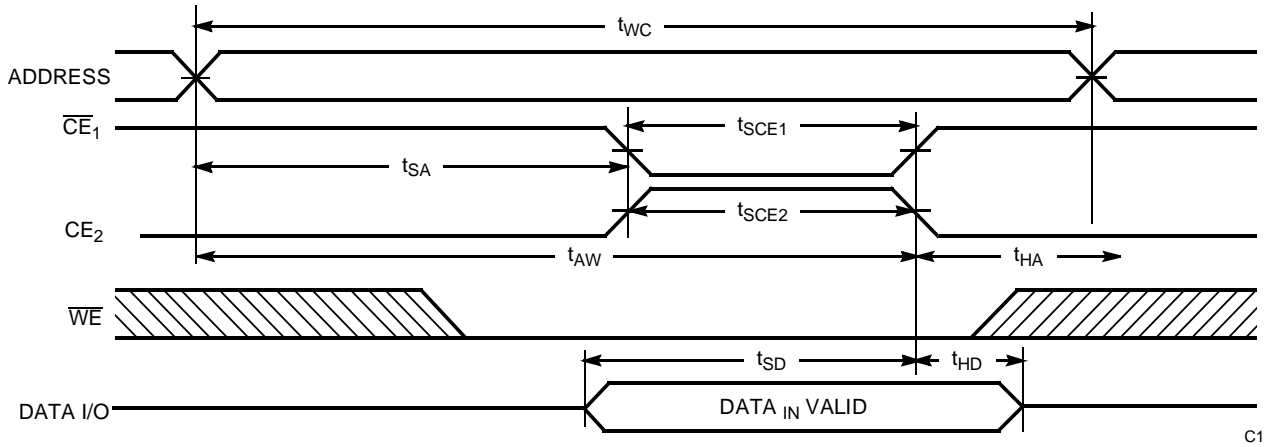
Switching Waveforms (continued)
Write Cycle No. 2 (\overline{CE} Controlled)^[12,13,14]

C185-9

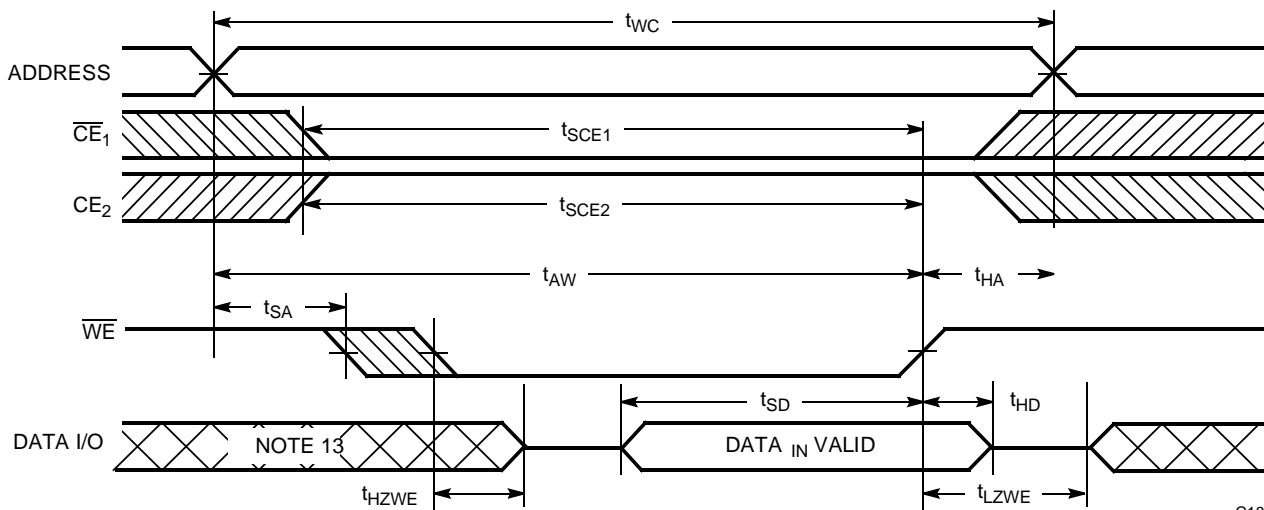
Write Cycle No. 3 (\overline{WE} Controlled, \overline{OE} LOW)^[12,13,14,15]

C185-10

Notes:

14. The minimum write cycle time for write cycle #3 (\overline{WE} controlled, \overline{OE} LOW) is the sum of t_{HZWE} and t_{SD} .
15. If \overline{CE}_1 goes HIGH or \overline{CE}_2 goes LOW simultaneously with \overline{WE} HIGH, the output remains in a high-impedance state.

Typical DC and AC Characteristics

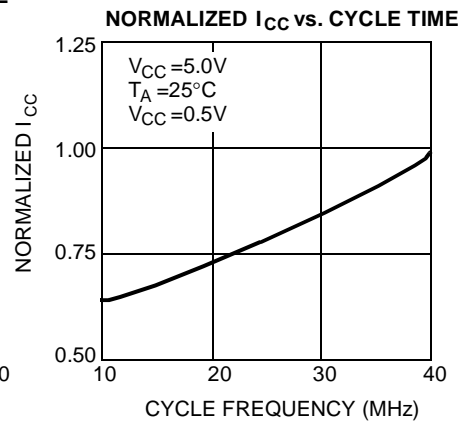
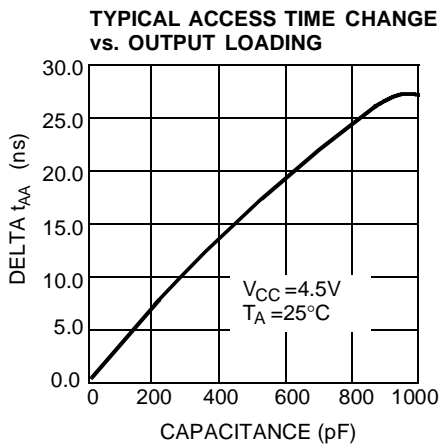
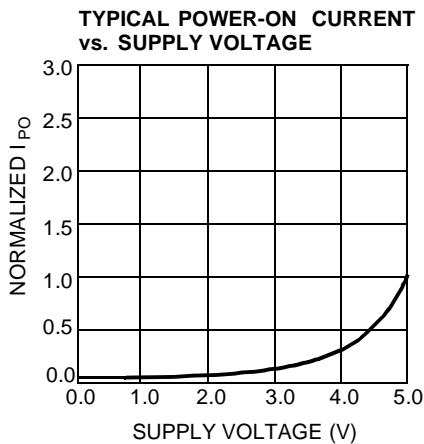
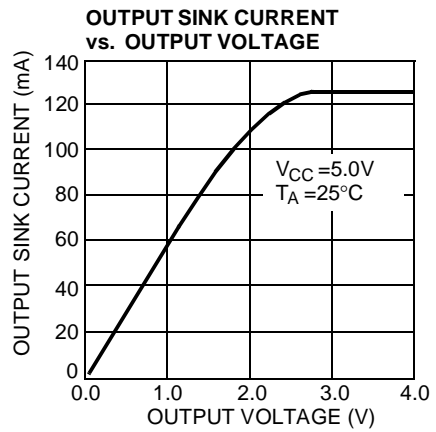
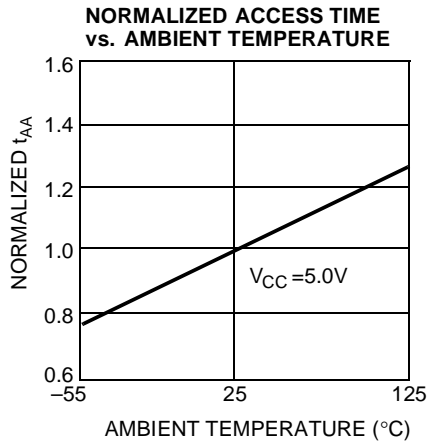
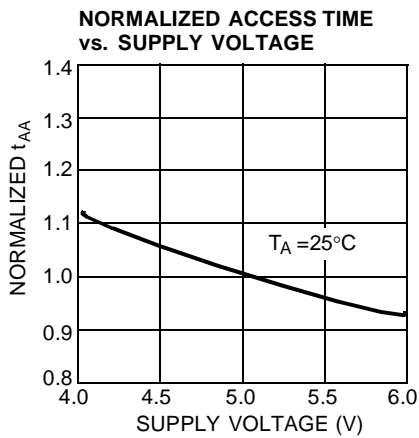
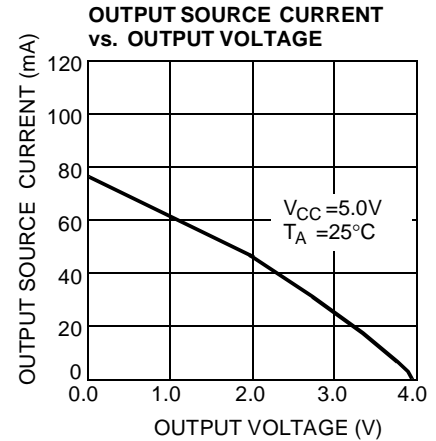
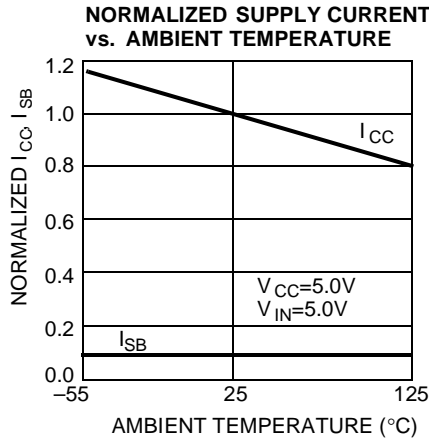
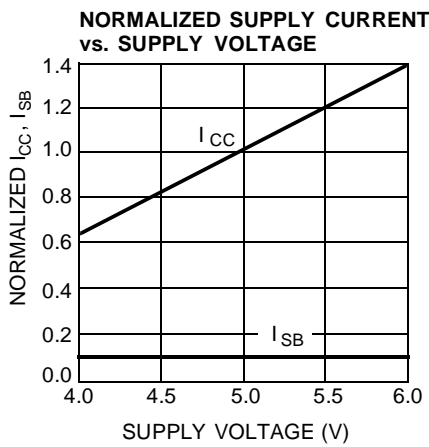

Truth Table

CE ₁	CE ₂	WE	OE	Input/Output	Mode
H	X	X	X	High Z	Deselect/Power-Down
X	L	X	X	High Z	Deselect/Power-Down
L	H	H	L	Data Out	Read
L	H	L	X	Data In	Write
L	H	H	H	High Z	Deselect

Address Designators

Address Name	Address Function	Pin Number
A4	X3	2
A5	X4	3
A6	X5	4
A7	X6	5
A8	X7	6
A9	Y1	7
A10	Y4	8
A11	Y3	9
A12	Y0	10
A0	Y2	21
A1	X0	23
A2	X1	24
A3	X2	25

Ordering Information

Speed (ns)	Ordering Code	Package Name	Package Type	Operating Range
15	CY7C185-15PC	P21	28-Lead (300-Mil) Molded DIP	Commercial
	CY7C185-15SC	S21	28-Lead Molded SOIC	
	CY7C185-15VC	V21	28-Lead Molded SOJ	
	CY7C185-15VI	V21	28-Lead Molded SOJ	Industrial
20	CY7C185-20PC	P21	28-Lead (300-Mil) Molded DIP	Commercial
	CY7C185-20SC	S21	28-Lead Molded SOIC	
	CY7C185-20VC	V21	28-Lead Molded SOJ	
	CY7C185-20VI	V21	28-Lead Molded SOJ	Industrial
25	CY7C185-25PC	P21	28-Lead (300-Mil) Molded DIP	Commercial
	CY7C185-25SC	S21	28-Lead Molded SOIC	
	CY7C185-25VC	V21	28-Lead Molded SOJ	
	CY7C185-25VI	V21	28-Lead Molded SOJ	Industrial
35	CY7C185-35PC	P21	28-Lead (300-Mil) Molded DIP	Commercial
	CY7C185-35SC	S21	28-Lead Molded SOIC	
	CY7C185-35VC	V21	28-Lead Molded SOJ	
	CY7C185-35VI	V21	28-Lead Molded SOJ	Industrial

Package Diagrams

28-Lead (300-Mil) Molded DIP P21

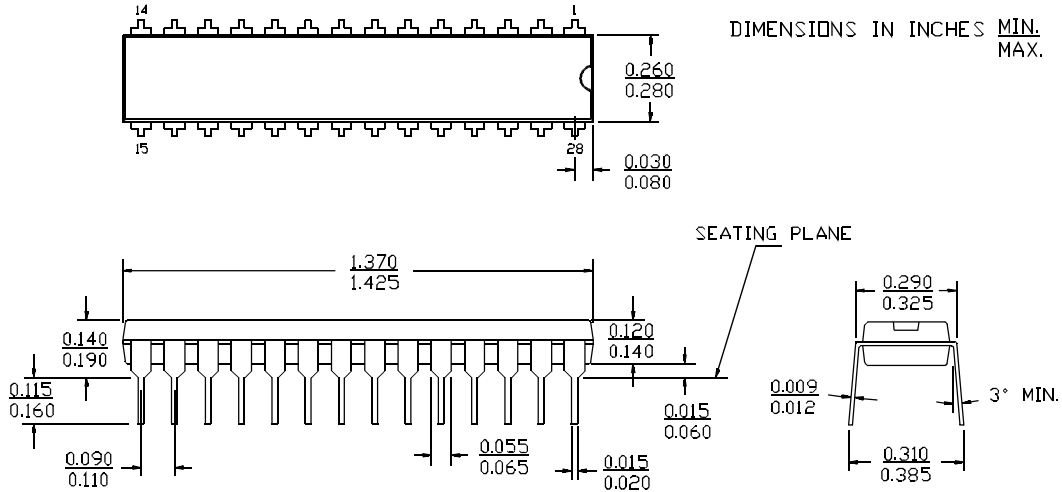

51-85014-B

28-Lead (300-Mil) Molded SOIC S21

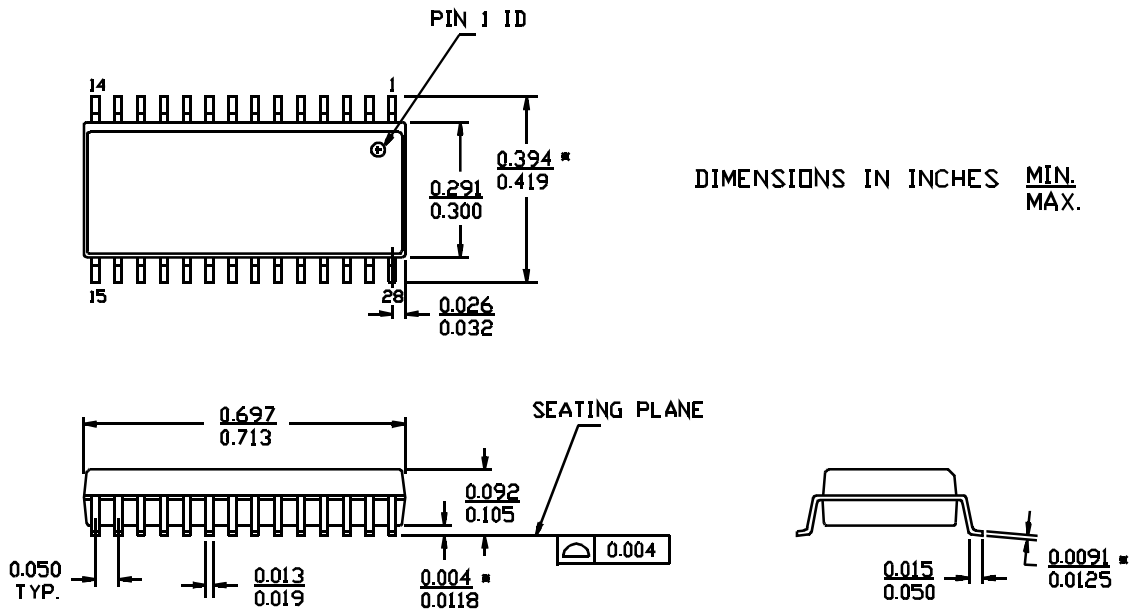

51-85026-A

Package Diagrams (continued)

28-Lead (300-Mil) Molded SOJ V21

DIMENSIONS IN INCHES MIN.
MAX.

