

Specifications

Insulation Resistance: 1,000M Ω min. at 500V DC
 Dielectric Withstanding Voltage: 700V AC for 1 minute
 Contact Resistance: 30m Ω max. at 10mA/20mV max.
 Current Rating: 1A max.
 Operating Temperature Range: -55°C to +170°C
 Mating Cycles: 10,000 insertions min.

Materials and Finish

Housing: Polyethersulphone (PES), glass-filled
 Contacts: Beryllium Copper (BeCu)
 Plating: Gold over Nickel

Features

- Clamshell socket for PLCC packages

Part Number (Details)

IC51 - 124 4 - 410-1

Series No.

No. of Contact Pins

Number of Sides with Contacts

Design Number



Outline Socket Dimensions

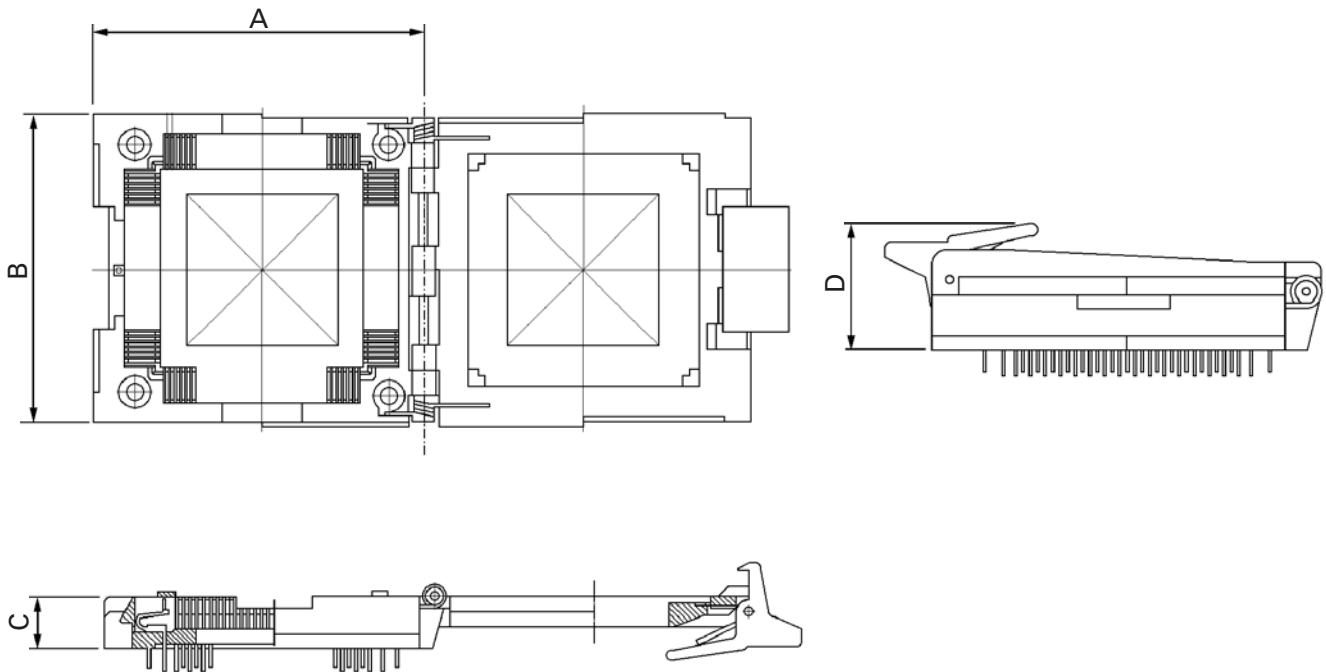

Part Number	Pin Count	Pitch	A	B	C (open)	D (closed)
IC51-0204-602	20	1.27	31.5	26.0	10.0	20.0
IC51-0284-399	28	1.27	36.0	30.0	10.0	20.5
IC51-0324-453	32	1.27	35.0	30.0	9.0	19.5
IC51-0444-400	44	1.27	40.0	34.0	10.0	20.0
IC51-0524-411-1	52	1.27	43.0	38.0	10.0	23.5
IC51-0684-390-1	68	1.27	49.0	42.0	10.0	23.5
IC51-0844-401-1	84	1.27	55.0	48.0	10.0	23.5
IC51-1004-405-1	100	1.27	60.6	54.0	10.0	23.5
IC51-1244-410-1	124	1.27	65.0	60.0	10.0	23.5

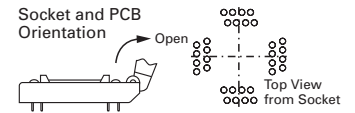

Recommended PCB Layouts

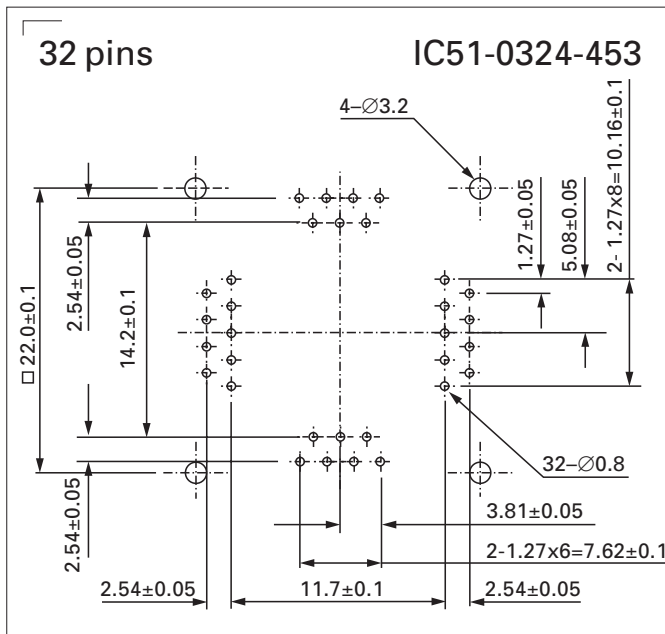
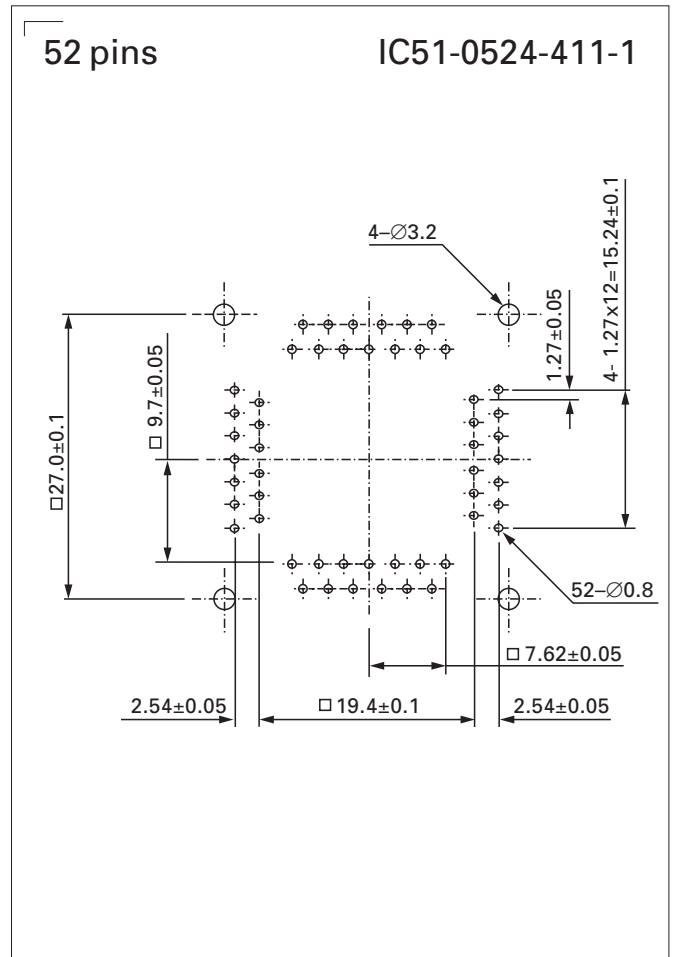
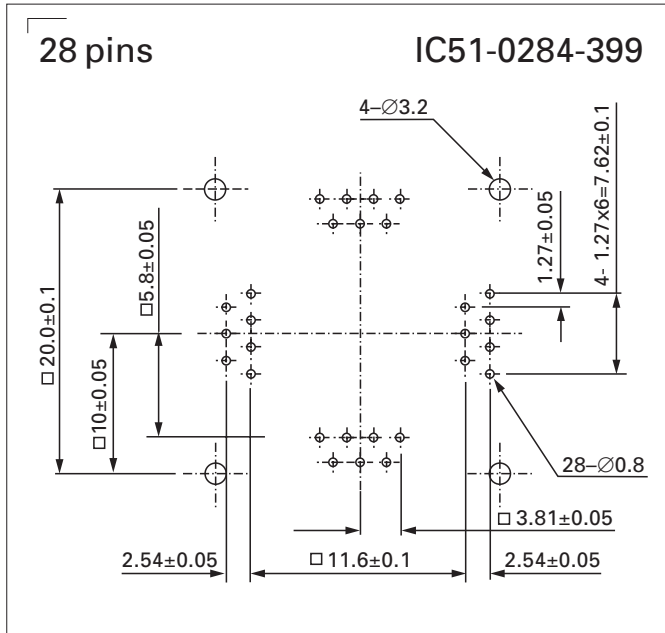
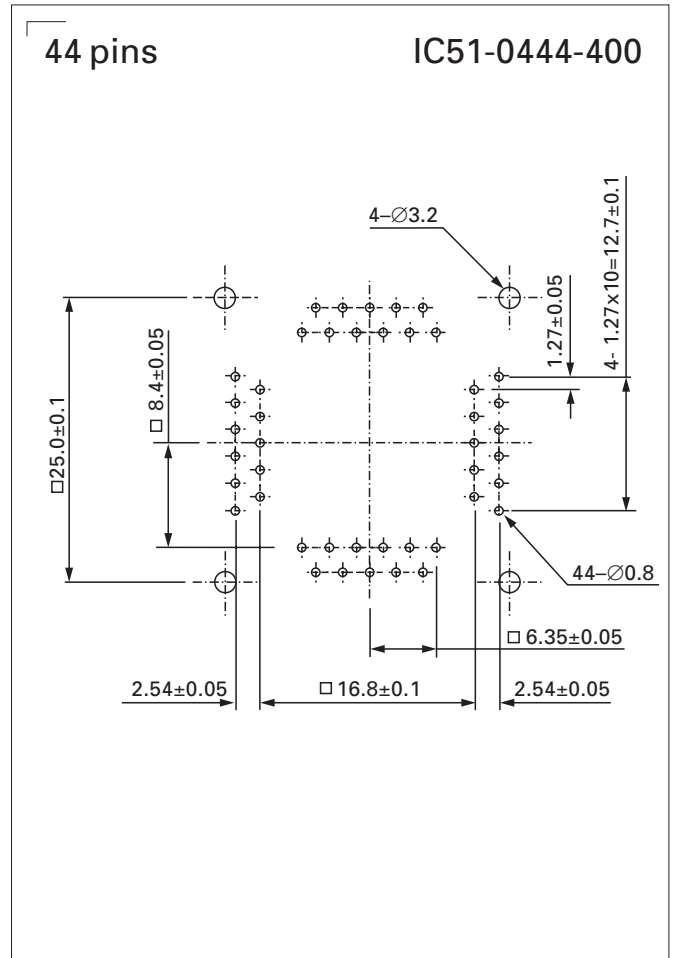
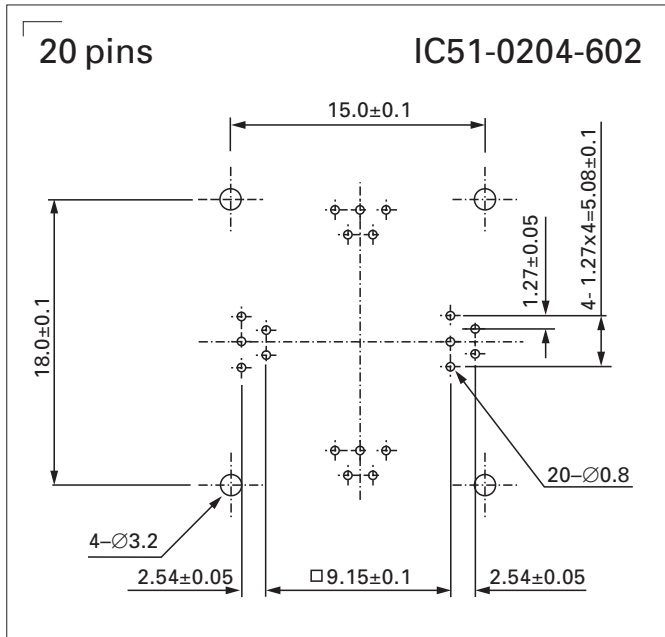

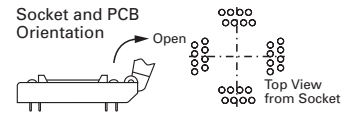

Recommended PCB Layouts

