

4496203 HITACHI/ LOGIC/ARRAYS/MEM  
**HN27C256G Series**

04E 13050 D

T-46-13-29

32768-word x 8-bit CMOS UV Erasable and Programmable ROM

■ FEATURES

- Low Power Dissipation ..... 40mW/MHz max. (Active Mode)  
 110μW max. (Stand-by Mode)
- Access Time ..... 170/200/250/300ns (max.)
- Single Power Supply ..... 5V ± 5%
- High Performance Programming ... Program Voltage: +12.5V DC
- Static ..... No Clocks Required
- Inputs and Outputs TTL Compatible During Both Read and Program Modes
- Absolute Max. Rating of V<sub>PP</sub> pin. . . 14.0V
- Device Identifier Mode ..... Manufacturer Code and Device Code
- Compatible with INTEL 27256

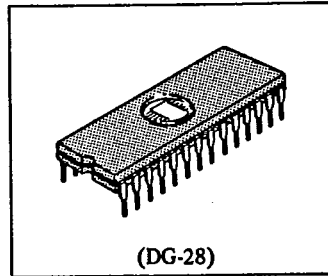

(DG-28)

■ PIN ARRANGEMENT

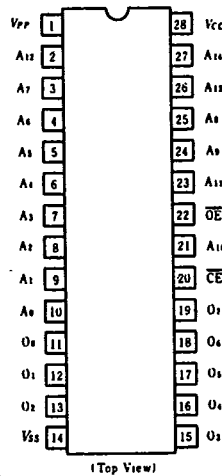

■ BLOCK DIAGRAM

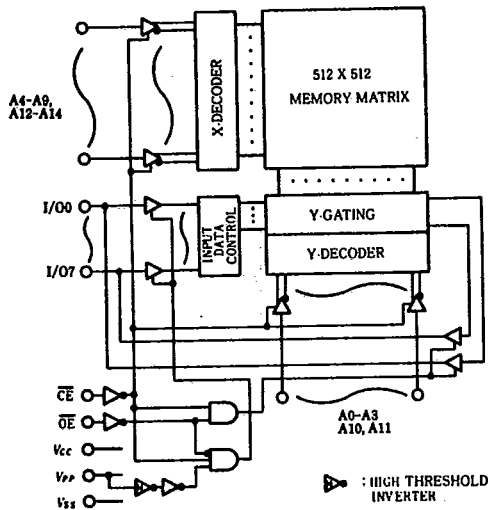

■ MODE SELECTION

Mode	Pins	CE (20)	OE (22)	A9 (24)	V <sub>PP</sub> (1)	V <sub>CC</sub> (28)	Outputs (11 - 13, 15 - 19)
Read		V <sub>IL</sub>	V <sub>IL</sub>	X	V <sub>CC</sub>	V <sub>CC</sub>	Dout
Output Disable		V <sub>IL</sub>	V <sub>IH</sub>	X	V <sub>CC</sub>	V <sub>CC</sub>	High Z
Standby		V <sub>IH</sub>	X	X	V <sub>CC</sub>	V <sub>CC</sub>	High Z
High Performance Program		V <sub>IL</sub>	V <sub>IH</sub>	X	V <sub>PP</sub>	V <sub>CC</sub>	Din
Program Verify		V <sub>IH</sub>	V <sub>IL</sub>	X	V <sub>PP</sub>	V <sub>CC</sub>	Dout
Optional Verify		V <sub>IL</sub>	V <sub>IL</sub>	X	V <sub>PP</sub>	V <sub>CC</sub>	Dout
Program Inhibit		V <sub>IH</sub>	V <sub>IH</sub>	X	V <sub>PP</sub>	V <sub>CC</sub>	High Z
Identifier		V <sub>IL</sub>	V <sub>IL</sub>	V <sub>H</sub> <sup>*2</sup>	V <sub>CC</sub>	V <sub>CC</sub>	Code

Notes) \*1. X: Don't care.  
 \*2. V<sub>H</sub>: 12.0V ± 0.5V.



4496203 HITACHI/ LOGIC/ARRAYS/MEM

04E 13051 D

HN27C256G Series

T-46-13-29

■ ABSOLUTE MAXIMUM RATINGS

Item	Symbol	Value	Unit
Operating Temperature Range	$T_{opr}$	0 to +70	°C
Storage Temperature Range	$T_{stg}$	-65 to +125	°C
Storage Temperature Range Under Bias	$T_{bias}$	-10 to +80	°C
All Input and Output Voltage*1	$V_{IN}, V_{OUT}$	-0.6*2 to +7	V
Voltage on Pin 24 (A9)*1	$V_{ID}$	-0.6*2 to +13.5	V
$V_{PP}$ Voltage*1	$V_{PP}$	-0.6 to +14	V
$V_{CC}$ Voltage*1	$V_{CC}$	-0.6 to +7	V

Notes: \*1. With respect to  $V_{SS}$ .  
\*2. -1.0V for pulse width  $\leq$  50ns.

■ READ OPERATION

● DC AND OPERATING CHARACTERISTICS ( $T_a = 0$  to +70°C,  $V_{CC} = 5V \pm 5\%$ ,  $V_{PP} = V_{CC}$ )

Parameter	Symbol	Test Condition	min	typ	max	Unit
Input Leakage Current	$I_{LI}$	$V_{in} = 5.25V$	-	-	2	$\mu A$
Output Leakage Current	$I_{LO}$	$V_{out} = 5.25V/0.45V$	-	-	2	$\mu A$
$V_{PP}$ Current	$I_{PP1}$	$V_{PP} = 5.5V$	-	1	20	$\mu A$
$V_{CC}$ Current (Standby)	$I_{SB1}$	$\overline{CE} = V_{IH}$	-	-	1	mA
	$I_{SB2}$	$\overline{CE} = V_{CC} \pm 0.3V$	-	1	20	$\mu A$
$V_{CC}$ Current (Active)	$I_{CC1}$	$\overline{CE} = V_{IL}, I_{out} = 0$ mA	-	-	30	mA
	$I_{CC2}$	$f = 5$ MHz, $I_{out} = 0$ mA	-	-	30	mA
	$I_{CC3}$	$f = 1$ MHz, $I_{out} = 0$ mA	-	-	8	mA
Input Voltage	$V_{IL}$		-0.3*1	-	0.8	V
	$V_{IH}$		2.2	-	$V_{CC} + 1.0$ *2	V
Output Voltage	$V_{OL}$	$I_{OL} = 2.1$ mA	-	-	0.45	V
	$V_{OH1}$	$I_{OH} = -400$ $\mu A$	2.4	-	-	V
	$V_{OH2}$	$I_{OH} = -100$ $\mu A$	$V_{CC} - 0.7$	-	-	V

Notes) \*1. -1.0V for pulse width  $\leq$  50ns.  
\*2.  $V_{CC} + 1.5V$  for pulse width  $\leq$  20ns. If  $V_{IH}$  is over the specified maximum value, read operation cannot be guaranteed.

● AC CHARACTERISTICS ( $T_a = 0$  to +70°C,  $V_{CC} = 5V \pm 5\%$ ,  $V_{PP} = V_{CC}$ )

Parameter	Symbol	Test Condition	HN27C256G-17		HN27C256G-20		HN27C256G-25		HN27C256G-30		Unit
			min.	max.	min.	max.	min.	max.	min.	max.	
Address to Output Delay	$t_{ACC}$	$\overline{CE} = \overline{OE} = V_{IL}$	-	170	-	200	-	250	-	300	ns
$\overline{CE}$ to Output Delay	$t_{CE}$	$\overline{OE} = V_{IL}$	-	170	-	200	-	250	-	300	ns
$\overline{OE}$ to Output Delay	$t_{OE}$	$\overline{CE} = V_{IL}$	10	60	10	70	10	100	10	120	ns
$\overline{OE}$ High to Output Float	$t_{DF}$	$\overline{CE} = V_{IL}$	0	50	0	50	0	60	0	105	ns
Address to Output Hold	$t_{OH}$	$\overline{CE} = \overline{OE} = V_{IL}$	0	-	0	-	0	-	0	-	ns

Note:  $t_{DF}$  defines the time at which the Output achieves the open circuit condition and Data is no longer driven.



4496203 HITACHI/ LOGIC/ARRAYS/MEM

04E 13052 D  
HN27C256G Series

T-46-13-29

SWITCHING CHARACTERISTICS

TEST CONDITION

- Input pulse levels: 0.45V to 2.4V
- Input rise and fall time:  $\leq 20\text{ns}$
- Output load: 1 TTL Gate +100pF
- Reference level for measuring timing: 0.8V and 2.0V

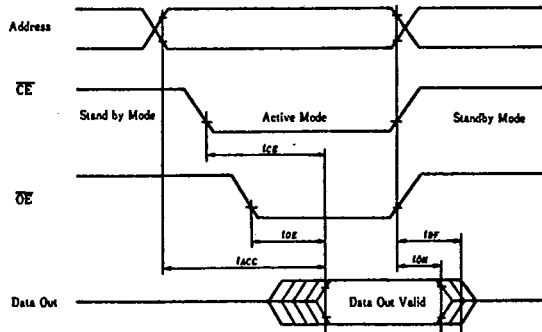

CAPACITANCE ( $T_a=25^\circ\text{C}$ ,  $f=1\text{MHz}$ )

Parameter	Symbol	Test Condition	Min.	Typ.	Max.	Unit.
Input Capacitance	$C_{in}$	$V_{in} = 0\text{V}$	-	4	6	pF
Output Capacitance	$C_{out}$	$V_{out} = 0\text{V}$	-	8	12	pF

HIGH PERFORMANCE PROGRAMMING

This device can be applied the High Performance Programming algorithm shown in following flowchart. This algorithm allows to obtain faster programming time without any voltage stress to the device nor deterioration in reliability of programmed data.

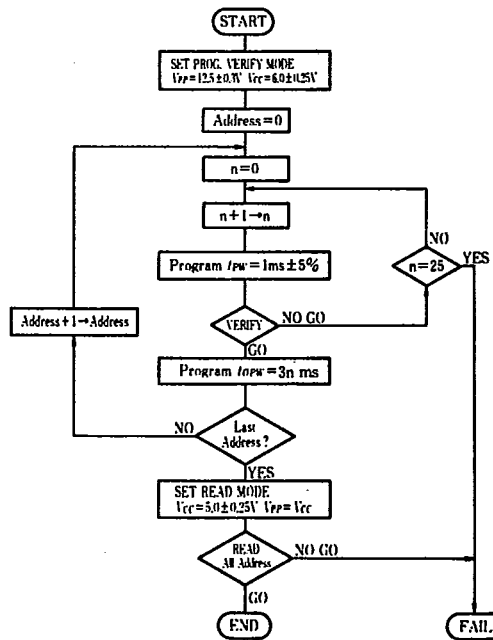

High Performance Programming Flowchart



4496203 HITACHI / LOGIC/ARRAYS/MEM

04E 13053 D

HN27C256G Series

T-46-13-29

■ HIGH PERFORMANCE PROGRAMMING OPERATION

● DC PROGRAMMING CHARACTERISTICS ( $T_a=25^{\circ}\text{C}\pm 5^{\circ}\text{C}$ ,  $V_{CC}=6\text{V}\pm 0.25\text{V}$ ,  $V_{PP}=12.5\text{V}\pm 0.3\text{V}$ )

Parameter	Symbol	Test Condition	min.	typ.	max.	Unit
Input Leakage Current	$I_{LI}$	$V_{IN} = 6.25\text{V}/0.45\text{V}$	-	-	2	$\mu\text{A}$
Output Low Voltage During Verify	$V_{OL}$	$I_{OL} = 2.1\text{mA}$	-	-	0.45	V
Output High Voltage During Verify	$V_{OH}$	$I_{OH} = -400\mu\text{A}$	2.4	-	-	V
$V_{CC}$ Current (Active)	$I_{CC2}$		-	-	30	mA
Input Low Level	$V_{IL}$		-0.1 <sup>*5</sup>	-	0.8	V
Input High Level	$V_{IH}$		2.2	-	$V_{CC}+0.5$ <sup>*6</sup>	V
$V_{PP}$ Supply Current	$I_{PP2}$	$\overline{\text{CE}} = V_{IL}$	-	-	40	mA

- Notes)\*1.  $V_{CC}$  must be applied before  $V_{PP}$  and removed after  $V_{PP}$ .  
 \*2.  $V_{PP}$  must not exceed 14V including overshoot.  
 \*3. An influence may be had upon device reliability if the device is installed or removed while  $V_{PP} = 12.5\text{V}$ .  
 \*4. Do not alter  $V_{PP}$  either  $V_{IL}$  to 12.5V or 12.5V to  $V_{IL}$  when  $\overline{\text{CE}} = \text{Low}$ .  
 \*5. -0.6V for pulse width  $\leq 20\text{ns}$ .  
 \*6. If  $V_{IH}$  is over the specified maximum value, programming operation cannot be guaranteed.

● AC PROGRAMMING CHARACTERISTICS ( $T_a=25^{\circ}\text{C}\pm 5^{\circ}\text{C}$ ,  $V_{CC}=6\text{V}\pm 0.25\text{V}$ ,  $V_{PP}=12.5\text{V}\pm 0.3\text{V}$ )

Parameter	Symbol	Test Condition	min.	typ.	max.	Unit
Address Setup Time	$t_{AS}$		2	-	-	$\mu\text{s}$
$\overline{\text{OE}}$ Setup Time	$t_{OES}$		2	-	-	$\mu\text{s}$
Data Setup Time	$t_{DS}$		2	-	-	$\mu\text{s}$
Address Hold Time	$t_{AH}$		0	-	-	$\mu\text{s}$
Data Hold Time	$t_{DH}$		2	-	-	$\mu\text{s}$
$\overline{\text{OE}}$ to Output Float Delay	$t_{DF}$		0	-	130	ns
$V_{PP}$ Setup Time	$t_{VPS}$		2	-	-	$\mu\text{s}$
$V_{CC}$ Setup Time	$t_{VCS}$		2	-	-	$\mu\text{s}$
$\overline{\text{CE}}$ Pulse Width During Initial Programming	$t_{PW}$		0.95	1.0	1.05	ms
$\overline{\text{CE}}$ Pulse Width During Overprogramming	$t_{OPW}$		2.85	-	78.75	ms
Data Valid from $\overline{\text{OE}}$	$t_{OE}$		0	-	150	ns

- Notes:  $t_{OPW}$  is defined as mentioned in flow chart.  
 $t_{DF}$  defines the time at which the output achieves the open circuit condition and data is no longer driven.

● SWITCHING CHARACTERISTICS

Test Condition  
 Input pulse level: 0.45V to 2.4V  
 Input rise and fall time:  $\leq 20\text{ns}$   
 Reference level for measuring time: 0.8V and 2V

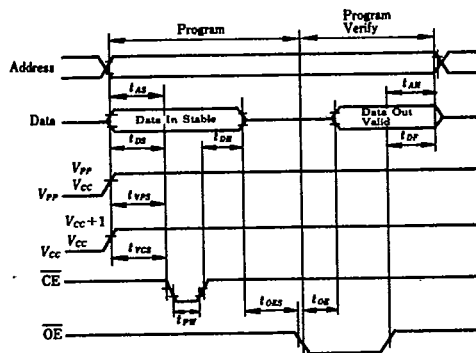

■ ERASE

Erasure of HN27C256G is performed by exposure to ultraviolet light of 2537 Å and all the output data are changed to "1" after this erasure procedure. The minimum integrated dose (i.e. UV intensity x exposure time) for erasure is 15W. sec/cm<sup>2</sup>



4496203 HITACHI/ LOGIC/ARRAYS/MEM

04E 13054 D

HN27C256G Series

● HN27C256G IDENTIFIER CODES

T-46-13-29

Identifier	Pins	A <sub>0</sub> (10)	O <sub>7</sub> (19)	O <sub>6</sub> (18)	O <sub>5</sub> (17)	O <sub>4</sub> (16)	O <sub>3</sub> (15)	O <sub>2</sub> (13)	O <sub>1</sub> (12)	O <sub>0</sub> (11)	Hex Data
Manufacturer Code	V <sub>IL</sub>	0	0	0	0	0	0	1	1	1	07
Device Code	V <sub>IH</sub>	1	0	1	1	0	0	0	0	0	B0

Notes: 1. A<sub>9</sub> = 12.0V ± 0.5V.  
2. A<sub>1</sub> - A<sub>8</sub>, A<sub>10</sub> - A<sub>14</sub>, CE, OE = V<sub>IL</sub>.

SUPPLY CURRENT VS. SUPPLY VOLTAGE

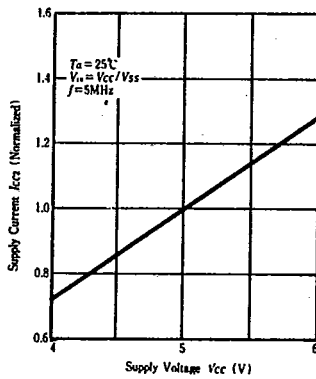

SUPPLY CURRENT VS. AMBIENT TEMPERATURE

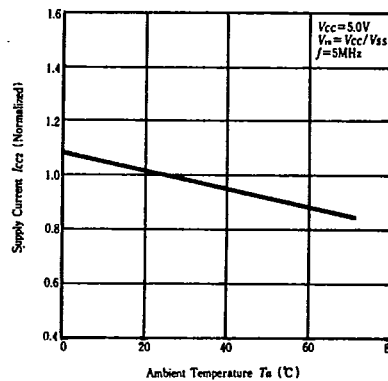

SUPPLY CURRENT VS. FREQUENCY

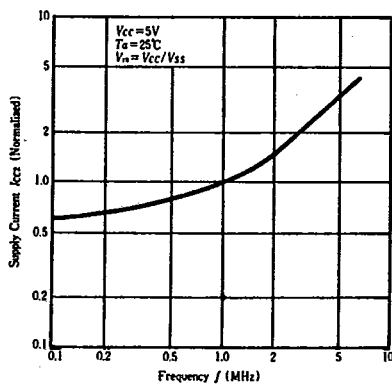

ACCESS TIME VS. LOAD CAPACITANCE

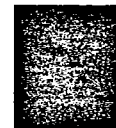
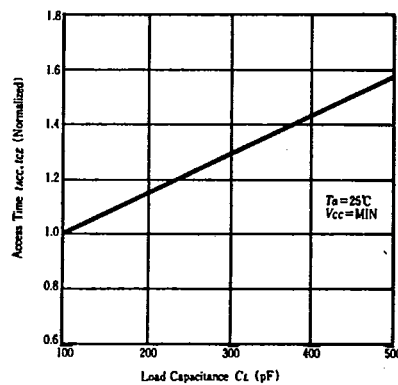

4496203 HITACHI/ LOGIC/ARRAYS/MEM  
HN27C256G Series

04E 13055 D

T-46-13-29

ACCESS TIME VS. SUPPLY VOLTAGE

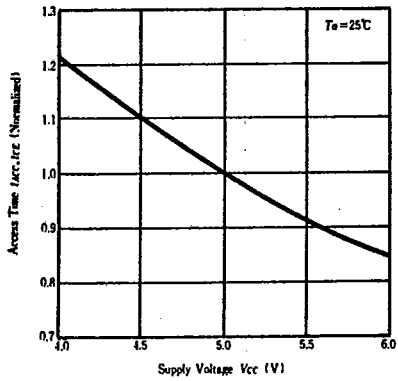

ACCESS TIME VS. AMBIENT TEMPERATURE

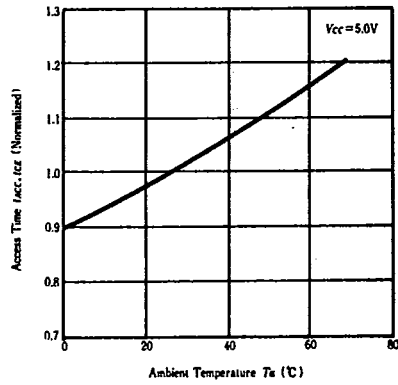

OUTPUT CURRENT VS. OUTPUT VOLTAGE

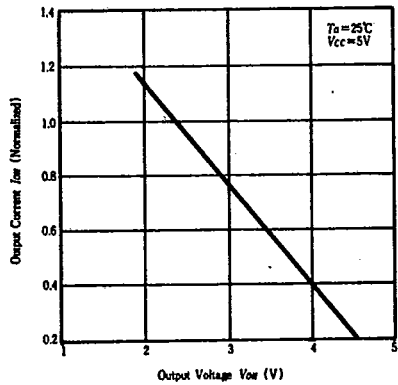

OUTPUT CURRENT VS. OUTPUT VOLTAGE

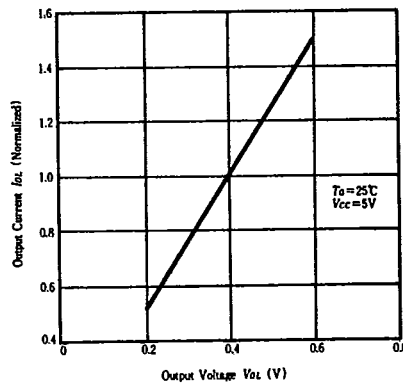

STANDBY CURRENT VS. AMBIENT TEMPERATURE

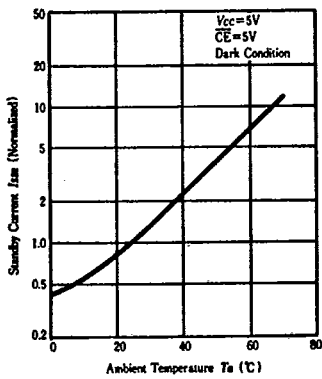

STANDBY CURRENT VS. SUPPLY VOLTAGE

