



27C010 1M (128K x 8) CHMOS EPROM

- JEDEC Approved EPROM Pinouts
 - 32-Pin DIP, 32-Pin PLCC
 - Simple Upgrade from Lower Densities
- Complete Upgrade Capability to Higher Densities
- Versatile EPROM Features
 - CMOS and TTL Compatibility
 - Two Line Control
- Fast Programming
 - Quick-Pulse Programming™ Algorithm
 - Programming Time as Fast as 15 Seconds
- High-Performance
 - 120 ns, $\pm 10\%$ V_{CC}
 - 30 mA I_{CC} Active
- Surface Mount Packaging Available
 - Smallest 1 Mbit Footprint in SMT

Intel's 27C010 is a 5V only, 1,048,576-bit, Erasable Programmable Read Only Memory, organized as 128,536 words of 8 bits. It is pin compatible with lower density DIP EPROMs (JEDEC) and provides for simple upgrades to 8 Mbits in the future in both DIP and PLCC.

The 27C010 represents state-of-the-art 1-micron CHMOS manufacturing technology while providing unequalled performance. Its 120 ns speed (t_{ACC}) offers no-wait-state operation with high performance CPUs in applications ranging from numerical control to office automation to telecommunications.

Intel offers two DIP profile options to meet your prototyping and production needs. The windowed ceramic DIP (CERDIP) package provides erasability and reprogrammability for prototyping and early production. Once the design is in full production, the plastic DIP (PDIP) one-time programmable part provides a lower cost alternative that is well adapted for auto insertion.

In addition to the JEDEC 32-pin DIP package, Intel also offers a 32-lead PLCC version of the 27C010. This one-time-programmable surface mount device is ideal where board space consumption is a major concern or where surface mount manufacturing technology is being implemented across an entire production line.

The 27C010 is equally at home in both a TTL or CMOS environment. It programs as fast as 15 seconds using Intel's industry leading Quick-Pulse Programming algorithm.

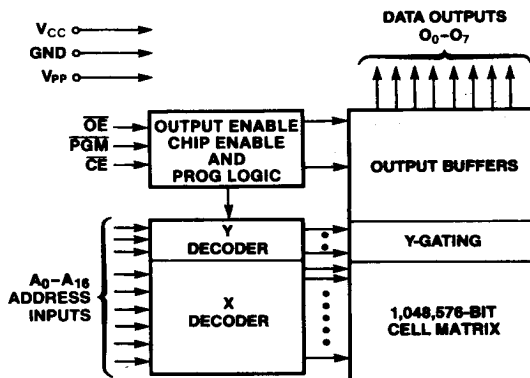
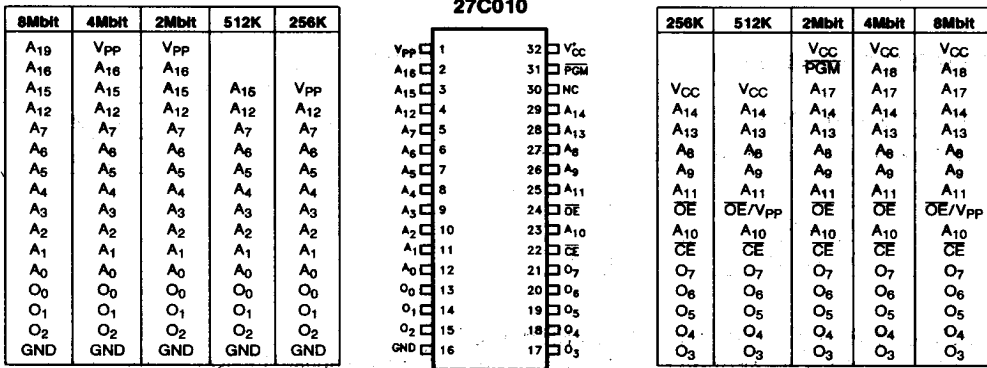

Figure 1. Block Diagram

290174-1

Pin Names

A ₀ -A ₁₉	ADDRESSES
CE	CHIP ENABLE
OE	OUTPUT ENABLE
O ₀ -O ₇	OUTPUTS
PGM	PROGRAM
NC	NO INTERNAL CONNECT



290174-2

Figure 2. DIP Pin Configuration

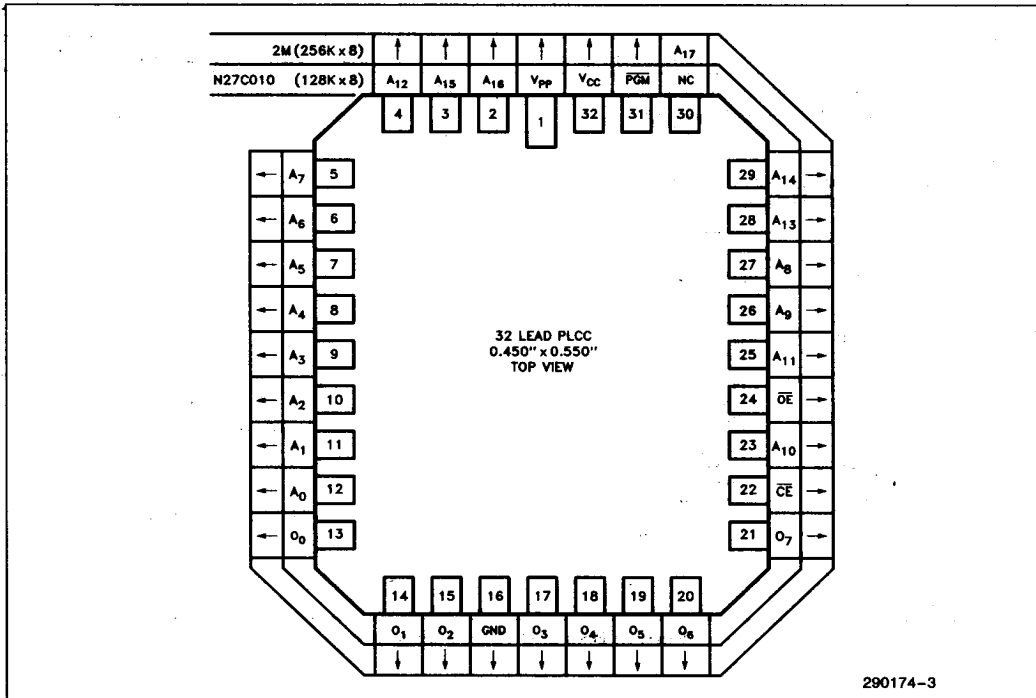

290174-3

Figure 3. PLCC Lead Configuration

EXTENDED TEMPERATURE (EXPRESS) EPROMs

The Intel EXPRESS EPROM family receives additional processing to enhance product characteristics. EXPRESS processing is available for several densities allowing the appropriate memory size to match system requirements. EXPRESS EPROMs are available with 168 ± 8 hour, 125°C dynamic

burn-in using Intel's standard bias configuration. This processing meets or exceeds most industry burn-in specifications. The EXPRESS product family is available in both 0°C to +70°C and -40°C to +85°C operating temperature range versions. Like all Intel EPROMs, the EXPRESS EPROM family is inspected to 0.1% electrical AQL. This allows reduction or elimination of incoming testing.

EXPRESS EPROM FAMILY

PRODUCT DEFINITIONS

Type	Operating Temperature	Burn-in 125°C (hr)
Q	0°C to 70°C	168 ± 8
T	-40°C to 85°C	None
L	-40°C to 85°C	168 ± 8

OPTIONS

Packaging	
Speed	CERDIP
150V10	Q, T, L

READ OPERATION DC CHARACTERISTICS

Electrical parameters of EXPRESS EPROM products are identical to standard EPROM parameters except for:

Symbol	Parameter	TD27C010(2) LD27C010		Test Condition
		Min	Max	
I _{CC} (1)	V _{CC} Operating Current (mA)		30	OE = CE = V _{IL} , T _{Ambient} = -40°C
	V _{CC} Operating Current at High Temperature (mA)		30	OE = CE = V _{IL} V _{PP} = V _{CC} , T _{Ambient} = 85°C

NOTES:

- Maximum current is with outputs O₀ to O₇ unloaded.
- D refers to the CERDIP package.

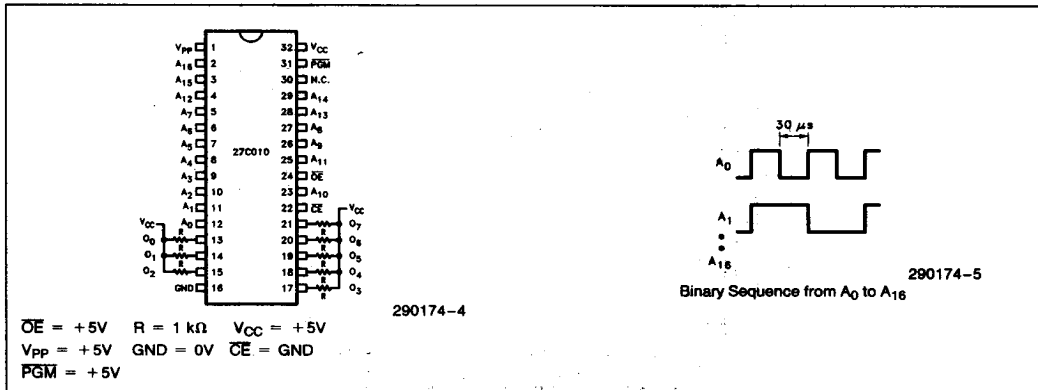

Burn-In Bias and Timing Diagrams

ABSOLUTE MAXIMUM RATINGS*

- Operating Temperature 0°C to 70°C(1)
- Temperature Under Bias -10°C to 80°C
- Storage Temperature -65°C to 125°C
- Voltage on Any Pin
(except A₉, V_{CC} and V_{PP})
with Respect to GND -0.6V to 6.5V(2, 8)
- Voltage on A₉ with
Respect to GND -0.6V to 13.0V(2)
- V_{PP} Program Voltage
with Respect to GND -0.6V to 14V(2)
- V_{CC} Supply Voltage
with Respect to GND -0.6V to 7.0V(2)

NOTICE: This is a production data sheet. The specifications are subject to change without notice.

**WARNING: Stressing the device beyond the "Absolute Maximum Ratings" may cause permanent damage. These are stress ratings only. Operation beyond the "Operating Conditions" is not recommended and extended exposure beyond the "Operating Conditions" may affect device reliability.*

READ OPERATION DC CHARACTERISTICS(1) V_{CC} = 5.0V ± 10%

Symbol	Parameter	Notes	Min	Typ	Max	Unit	Test Condition
I _{LI}	Input Load Current	7		0.01	1.0	μA	V _{IN} = 0V to 5.5V
I _{LO}	Output Leakage Current				± 10	μA	V _{OUT} = 0V to 5.5V
I _{SB}	V _{CC} Standby Current				1.0	mA	CE = V _{IH}
					100	μA	CE = V _{CC} ± 0.2V
I _{CC}	V _{CC} Operating Current	3			30	mA	CE = V _{IL} f = 5 MHz, I _{OUT} = 0 mA
I _{PP}	V _{PP} Operating Current	3			10	μA	V _{PP} = V _{CC}
I _{OS}	Output Short Circuit Current	4, 6			100	mA	
V _{IL}	Input Low Voltage		-0.5		0.8	V	
V _{IH}	Input High Voltage		2.0		V _{CC} + 0.5	V	
V _{OL}	Output Low Voltage				0.45	V	I _{OL} = 2.1 mA
V _{OH}	Output High Voltage		2.4			V	I _{OH} = -400 μA
V _{PP}	V _{PP} Operating Voltage	5	V _{CC} - 0.7		V _{CC}	V	

NOTES:

1. Operating temperature is for commercial product defined by this specification. Extended temperature options are available in EXPRESS versions.
2. Minimum DC voltage is -0.5V on input/output pins. During transitions, this level may undershoot to -2.0V for periods < 20 ns. Maximum DC voltage on input/output pins is V_{CC} + 0.5V which, during transitions, may overshoot to V_{CC} + 2.0V for periods < 20 ns.
3. Maximum active power usage is the sum I_{PP} + I_{CC}. Maximum current is with outputs O₀ to O₇ unloaded.
4. Output shorted for no more than one second. No more than one output shorted at a time.
5. V_{PP} may be connected directly to V_{CC}, or may be one diode voltage drop below V_{CC}. V_{CC} must be applied simultaneously or before V_{PP} and removed simultaneously or after V_{PP}.
6. Sampled, not 100% tested.
7. Typical limits are at V_{CC} = 5V, T_A = 25°C.
8. Absolute Maximum Ratings apply to NC pins.

5

READ OPERATION AC CHARACTERISTICS(1) $V_{CC} = 5.0V \pm 10\%$

Versions(4)		$V_{CC} \pm 10\%$	27C010-120V10		27C010-150V10 P27C010-150V10 N27C010-150V10		27C010-200V10 P27C010-200V10 N27C010-200V10		Units
			Min	Max	Min	Max	Min	Max	
Symbol	Parameter	Notes	Min	Max	Min	Max	Min	Max	
t_{ACC}	Address to Output Delay			120		150		200	ns
t_{CE}	\overline{CE} to Output Delay	2		120		150		200	ns
t_{OE}	\overline{OE} to Output Delay	2		55		60		70	ns
t_{DF}	\overline{OE} High to Output High Z	3		30		50		60	ns
t_{OH}	Output Hold from Addresses, \overline{CE} or \overline{OE} Change-Whichever is First	3	0		0		0		ns

NOTES:

1. See AC Input/Output Reference Waveform for timing measurements.
2. \overline{OE} may be delayed up to $t_{CE}-t_{OE}$ after the falling edge of \overline{CE} without impact on t_{OE} .
3. Sampled, not 100% tested.
4. Model Number Prefixes: No Prefix = CERDIP, P = PDIP, N = PLCC.

CAPACITANCE(1) $T_A = 25^\circ\text{C}, f = 1\text{MHz}$

Symbol	Parameter	Typ(2)	Max	Unit	Conditions
C_{IN}	Input Capacitance	4	8	pF	$V_{IN} = 0V$
C_{OUT}	Output Capacitance	8	12	pF	$V_{OUT} = 0V$
C_{VPP}	V_{PP} Capacitance	18	25	pF	$V_{PP} = 0V$

NOTES:

1. Sampled, not 100% tested.
2. Typical values are for $T_A = 25^\circ\text{C}$ and nominal supply voltages.

AC INPUT/OUTPUT REFERENCE WAVEFORM

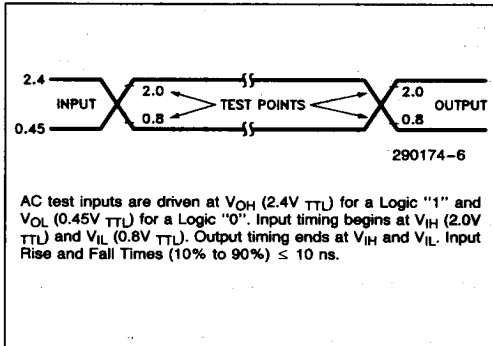

AC TESTING LOAD CIRCUIT

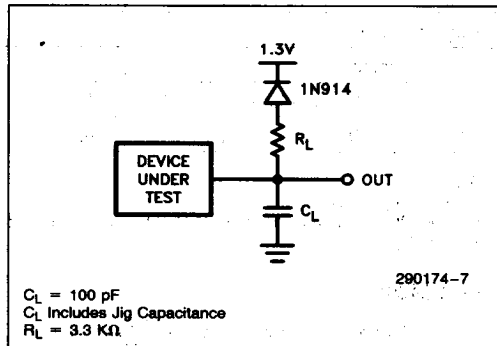

AC WAVEFORMS

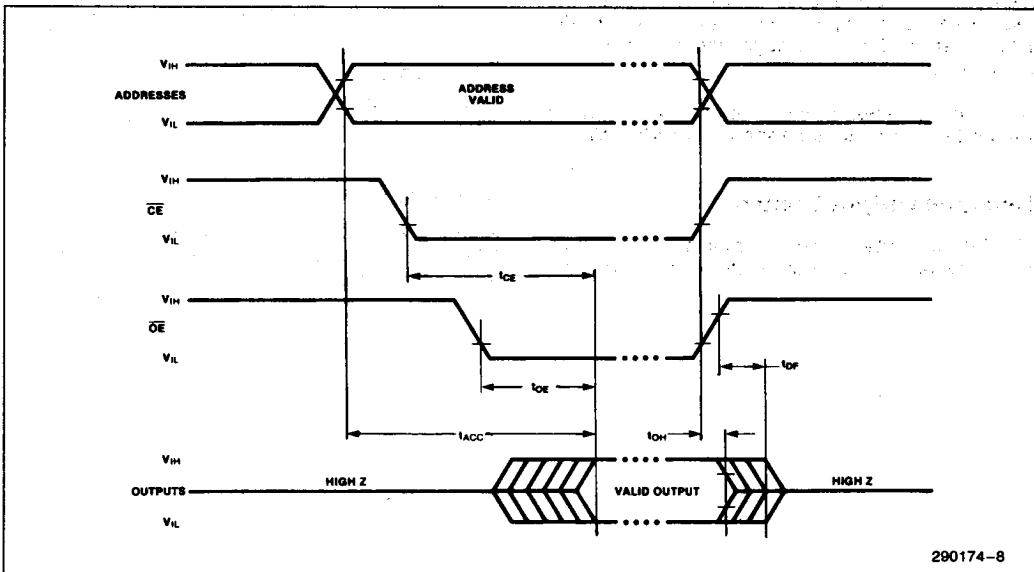

DEVICE OPERATION

The Mode Selection table lists 27C010 operating modes. Read Mode requires a single 5V power supply. All inputs, except V_{CC} and V_{PP}, and A₉ during intelligent Identifier Mode, are TTL or CMOS.

Table 1. Mode Selection

Mode	Notes	\overline{CE}	\overline{OE}	PGM	A ₉	A ₀	V _{PP}	V _{CC}	Outputs	
Read	1	V _{IL}	V _{IL}	X	X	X	V _{CC}	V _{CC}	D _{OUT}	
Output Disable		V _{IL}	V _{IH}	X	X	X	V _{CC}	V _{CC}	High Z	
Standby		V _{IH}	X	X	X	X	V _{CC}	V _{CC}	High Z	
Program	2	V _{IL}	V _{IH}	V _{IL}	X	X	V _{PP}	V _{CP}	D _{IN}	
Program Verify		V _{IL}	V _{IL}	V _{IH}	X	X	V _{PP}	V _{CP}	D _{OUT}	
Program Inhibit		V _{IH}	X	X	X	X	V _{PP}	V _{CP}	High Z	
intelligent Identifier	Manufacturer	2, 3	V _{IL}	V _{IL}	X	V _{ID}	V _{IL}	V _{CC}	V _{CC}	89 H
	Device		V _{IL}	V _{IL}	X	V _{ID}	V _{IH}	V _{CC}	V _{CC}	35 H

NOTES:

1. X can be V_{IL} or V_{IH}.
2. See DC Programming Characteristics for V_{CP}, V_{PP} and V_{ID} voltages.
3. A₁-A₈, A₁₀-A₁₆ = V_{IL}.

Read Mode

The 27C010 has two control functions: both must be enabled to obtain data at the outputs. \overline{CE} is the power control and device select. \overline{OE} controls the output buffers to gate data to the outputs. With addresses stable, the address access time (t_{ACC}) equals the delay from \overline{CE} to output (t_{CE}). Outputs display valid data t_{OE} after \overline{OE} 's falling edge, assuming t_{ACC} and t_{CE} times are met.

V_{CC} must be applied simultaneously or before V_{PP} and removed simultaneously or after V_{PP}.

Two Line Output Control

EPROMs are often used in larger memory arrays. Intel provides two control inputs to accommodate

multiple memory connections. Two-line control provides for:

- a) lowest possible memory power dissipation
- b) complete assurance that data bus contention will not occur

To efficiently use these two control inputs, an address decoder should enable \overline{CE} , while \overline{OE} should be connected to all memory devices and the system's READ control line. This assures that only selected memory devices have active outputs while deselected memory devices are in Standby Mode.

Standby Mode

Standby Mode substantially reduces V_{CC} current. When $\overline{CE} = V_{IH}$, the outputs are in a high impedance state, independent of \overline{OE} .

Program Mode

Caution: Exceeding 14V on V_{PP} will permanently damage the device.

Initially, and after each erasure, all EPROM bits are in the "1" state. Data is introduced by selectively programming "0s" into the desired bit locations. Although only "0s" are programmed, the data word can contain both "1s" and "0s". Ultraviolet light erasure is the only way to change "0s" to "1s".

Program Mode is entered when V_{PP} is raised to 12.75V. Data is introduced by applying an 8-bit word to the output pins. Pulsing \overline{PGM} low while $\overline{CE} = V_{IL}$ and $\overline{OE} = V_{IH}$ programs that data into the device.

Program Verify

A verify should be performed following a program operation to determine that bits have been correctly programmed. With V_{CC} at 6.25V, a substantial program margin is ensured. The verify is performed with \overline{CE} at V_{IL} and \overline{PGM} at V_{IH} . Valid data is available t_{OE} after \overline{OE} falls low.

Program Inhibit

Program Inhibit Mode allows parallel programming of multiple EPROMs with different data. \overline{CE} -high inhibits programming of non-targeted devices. Except for \overline{CE} , parallel EPROMs may have common inputs.

Intelligent Identifier™ Mode

The Intelligent Identifier Mode will determine an EPROM's manufacturer and device type, allowing programming equipment to automatically match a device with its proper programming algorithm.

This mode is activated when a programmer forces 12V \pm 0.5V on A_9 . With \overline{CE} , \overline{OE} , A_1 - A_8 , and A_{10} - A_{16} at V_{IL} , $A_0 = V_{IL}$ will present the manufacturer code and $A_0 = V_{IH}$ the device code. This mode functions in the 25°C \pm 5°C ambient temperature range required during programming.

UPGRADE PATH

Future upgrade to 2-Mbit, 4-Mbit, and 8-Mbit densities are easily accomplished due to the standardized pin configuration of the 27C010. When the 27C010 is in Read Mode, the \overline{PGM} input becomes non-

functional. The \overline{PGM} and NC pins may be V_{IL} or V_{IH} . This allows address lines A_{17} - A_{18} to be routed directly to these inputs in anticipation of future density upgrades. A jumper between V_{CC} and A_{19} allows further upgrade using the V_{PP} pin. Systems designed for 1-Mbit program memories today can be upgraded to higher densities (2-Mbit, 4-Mbit, and 8-Mbit) in the future with no circuit board changes.

SYSTEM CONSIDERATIONS

EPROM power switching characteristics require careful device decoupling. System designers are interested in 3 supply current issues: standby current levels (I_{SB}), active current levels (I_{CC}), and transient current peaks produced by falling and rising edges of \overline{CE} . Transient current magnitudes depend on the device output's capacitive and inductive loading. Two-line control and proper decoupling capacitor selection will suppress transient voltage peaks. Each device should have a 0.1 μ F ceramic capacitor connected between its V_{CC} and GND. This high frequency, low inherent-inductance capacitor should be placed as close as possible to the device. Additionally, for every 8 devices, a 4.7 μ F electrolytic capacitor should be placed at the array's power supply connection between V_{CC} and GND. The bulk capacitor will overcome voltage slumps caused by PC board trace inductances.

ERASURE CHARACTERISTICS

Erasure begins when EPROMs are exposed to light with wavelengths shorter than approximately 4000 Angstroms (\AA). It should be noted that sunlight and certain fluorescent lamps have wavelengths in the 3000 \AA -4000 \AA range. Data shows that constant exposure to room level fluorescent lighting can erase an EPROM in approximately 3 years, while it takes approximately 1 week when exposed to direct sunlight. If the device is exposed to these lighting conditions for extended periods, opaque labels should be placed over the window to prevent unintentional erasure.

The recommended erasure procedure is exposure to ultraviolet light of wavelength 2537 \AA . The integrated dose (UV intensity \times exposure time) for erasure should be a minimum of 15 Wsec/cm². Erasure time is approximately 15 to 20 minutes using an ultraviolet lamp with a 12000 μ W/cm² power rating. The EPROM should be placed within 1 inch of the lamp tubes. An EPROM can be permanently damaged if the integrated dose exceeds 7258 Wsec/cm² (1 week @ 12000 μ W/cm²).

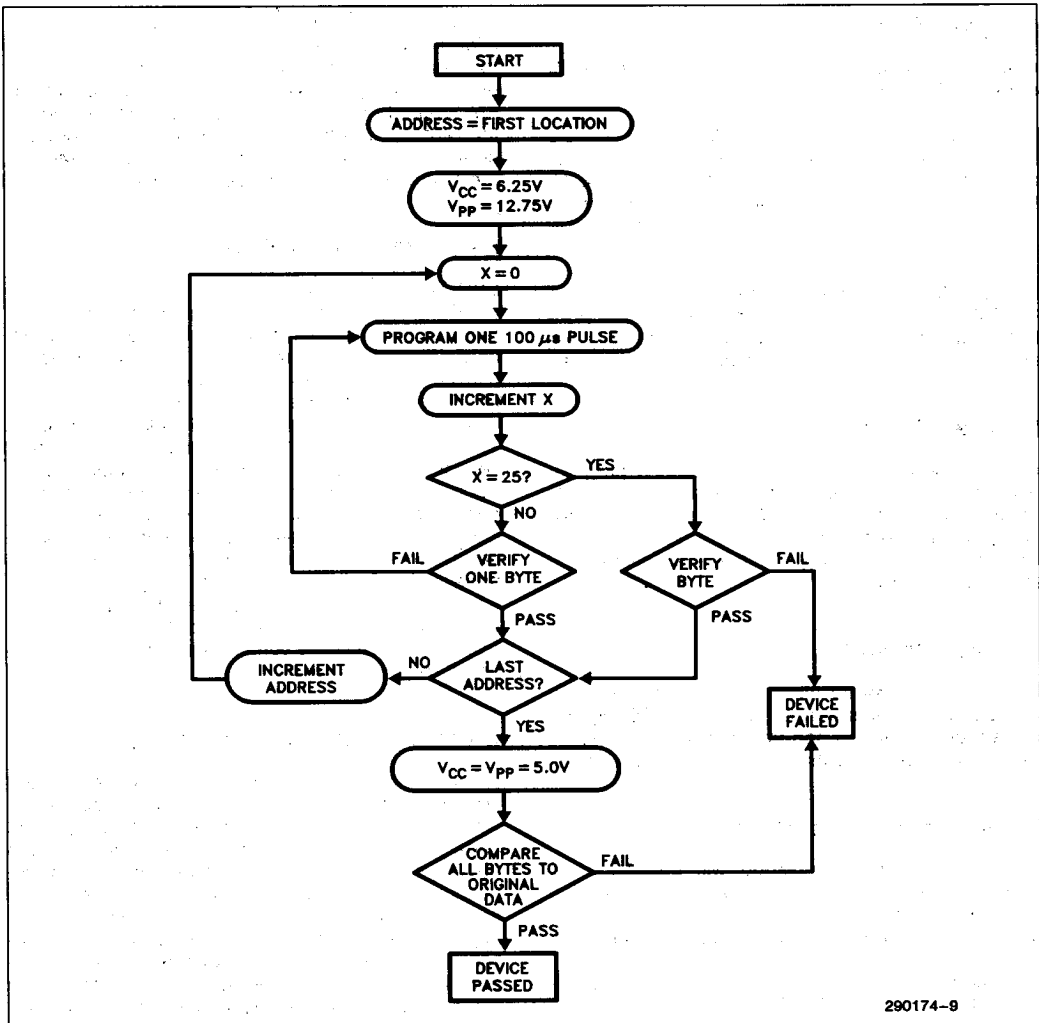

290174-9

Figure 4. Quick-Pulse Programming™ Algorithm

Quick-Pulse Programming™ Algorithm

The Quick-Pulse programming algorithm programs Intel's 27C010. Developed to substantially reduce programming throughput, this algorithm can program the 27C010 as fast as 15 seconds. Actual programming time depends on programmer overhead.

The Quick-Pulse programming algorithm employs a 100 μs pulse followed by a byte verification to deter-

mine when the addressed byte has been successfully programmed. The algorithm terminates if 25 attempts fail to program a byte.

The entire program pulse/byte verify sequence is performed with V_{PP} = 12.75V and V_{CC} = 6.25V. When programming is complete, all bytes are compared to the original data with V_{CC} = V_{PP} = 5.0V.

DC PROGRAMMING CHARACTERISTICS $T_A = 25^\circ\text{C} \pm 5^\circ\text{C}$

Symbol	Parameter	Notes	Min	Typ	Max	Unit	Test Condition
I_{LI}	Input Load Current				1	μA	$V_{IN} = V_{IL}$ or V_{IH}
I_{CP}	V_{CC} Program Current	1			40	mA	$\overline{CE} = \overline{PGM} = V_{IL}$
I_{PP}	V_{PP} Program Current	1			50	mA	$\overline{CE} = \overline{PGM} = V_{IL}$
V_{IL}	Input Low Voltage		-0.1		0.8	V	
V_{IH}	Input High Voltage		2.4		6.5	V	
V_{OL}	Output Low Voltage (Verify)				0.45	V	$I_{OL} = 2.1 \text{ mA}$
V_{OH}	Output High Voltage (Verify)		3.5			V	$I_{OH} = -2.5 \text{ mA}$
V_{ID}	A_9 intelligent Identifier Voltage		11.5	12.0	12.5	V	
V_{PP}	V_{PP} Program Voltage	2, 3	12.5	12.75	13.0	V	
V_{CP}	V_{CC} Supply Voltage (Program)	2	6.0	6.25	6.5	V	

AC PROGRAMMING CHARACTERISTICS(4) $T_A = 25^\circ\text{C} \pm 5^\circ\text{C}$

Symbol	Parameter	Notes	Min	Typ	Max	Unit
t_{VCS}	V_{CP} Setup Time	2	2			μs
t_{VPS}	V_{PP} Setup Time	2	2			μs
t_{CES}	\overline{CE} Setup Time		2			μs
t_{AS}	Address Setup Time		2			μs
t_{DS}	Data Setup Time		2			μs
t_{PW}	\overline{PGM} Program Pulse Width		95	100	105	μs
t_{DH}	Data Hold Time		2			μs
t_{OES}	\overline{OE} Setup Time		2			μs
t_{OE}	Data Valid from \overline{OE}	5			150	ns
t_{DFP}	\overline{OE} High to Output High Z	5, 6	0		130	ns
t_{AH}	Address Hold Time		0			μs

NOTES:

1. Maximum current is with outputs O_0 - O_7 unloaded.
2. V_{CP} must be applied simultaneously or before V_{PP} and removed simultaneously or after V_{PP} .
3. When programming, a 0.1 μF capacitor is required across V_{PP} and GND to suppress spurious voltage transients which can damage the device.
4. See AC Input/Output Reference Waveform for timing measurements.
5. t_{OE} and t_{DFP} are device characteristics but must be accommodated by the programmer.
6. Sampled, not 100% tested.

5

PROGRAMMING WAVEFORMS

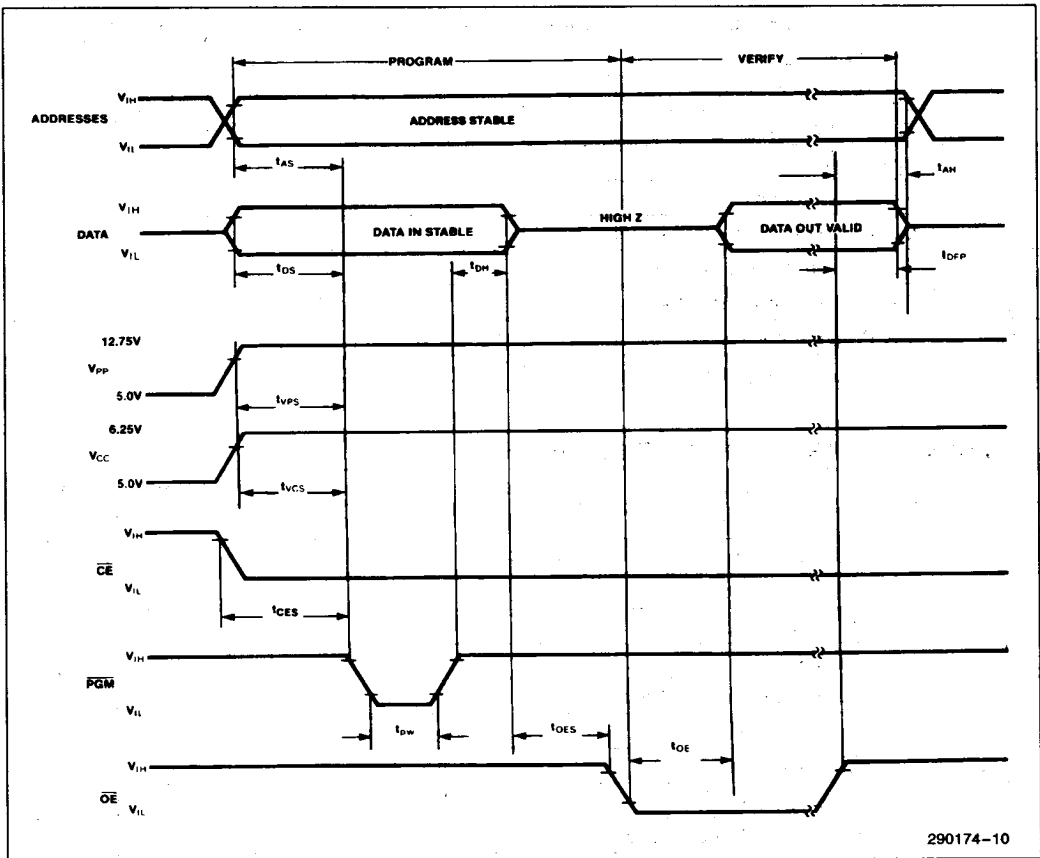

REVISION HISTORY

Number	Description
04	Revised general datasheet structure, text to improve clarity. Added PDIP package Combined TTL/NMOS and CMOS Read Operation DC Characteristics tables. Deleted 4 Meg and 8 Meg PLCC pinout references.