

SONY

CXK58257AP/ASP/AM -70L/10L/12L
-70LL/10LL/12LL *

32768-word × 8-bit High Speed CMOS Static RAM

Description

CXK58257AP/ASP/AM is 262,144 bits high speed CMOS static RAM organized as 32,768 words by 8 bits and operates from a single 5V supply. This device is suitable for use in high speed and low power applications in which battery back up for nonvolatility is required.

* 300mil DIP covers only L-version.

Features

- Fast access time: (Access time)
CXK58257AP/ASP/AM-70L, 70LL 70ns(Max.)
CXK58257AP/ASP/AM-10L, 10LL 100ns(Max.)
CXK58257AP/ASP/AM-12L, 12LL 120ns(Max.)
- Low power operation:
CXK58257AP/AM-70LL, 10LL, 12LL ;
Standby : 1 μW (Typ.)
Operation : 15mW (Typ.)
CXK58257AP/ASP/AM-70L, 10L, 12L ;
Standby : 2.5 μW (Typ.)
Operation : 15mW (Typ.)
- Single +5V supply : +5V ± 10%
- Fully static memory...No clock or timing strobe required
- Equal access and cycle time
- Common data input and output :
three state output
- Directly TTL compatible :
All inputs and outputs

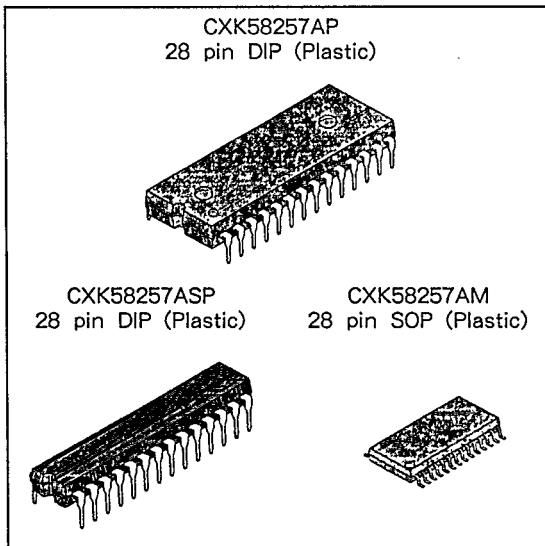

- Low voltage data retention : 2.0V (Min.)
- Available in 28 pin 600mil DIP, 300mil DIP and 450mil SOP

Function

32768-word × 8-bit static RAM

Structure

Silicon gate CMOS IC

Block Diagram

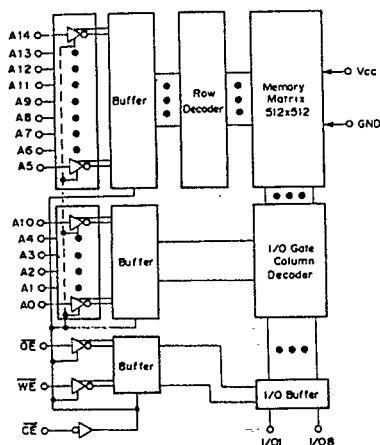

Pin Configuration (Top View)

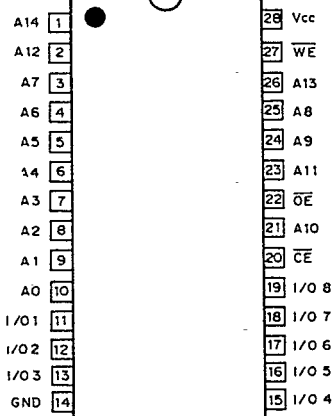

Pin Description

Symbol	Description
A0 to A14	Address input
I/O1 to I/O8	Data input/output
\overline{CE}	Chip enable input
\overline{WE}	Write enable input
\overline{OE}	Output enable input
Vcc	+5V power supply
GND	Ground

E90447B46 - ST

Absolute Maximum Ratings

(Ta = 25°C, GND = 0V)

Item	Symbol	Rating	Unit	
Supply voltage	V _{CC}	- 0.5 to + 7.0	V	
Input voltage	V _{IN}	- 0.5* to V _{CC} + 0.5	V	
Input and output voltage	V _{I/O}	- 0.5* to V _{CC} + 0.5	V	
Allowable power dissipation	P _D	CXK58257AP/ASP	1.0	W
		CXK58257AM	0.7	
Operating temperature	T _{opr}	0 to + 70	°C	
Storage temperature	T _{stg}	- 55 to + 150	°C	
Soldering temperature	T _{solder}	260 • 10	°C • sec	

* V_{IN}, V_{I/O} = - 3.0V Min. for pulse width less than 50ns.**Truth Table**

\overline{CE}	\overline{OE}	\overline{WE}	Mode	I/O1 to I/O8	V _{CC} Current
H	X	X	Not selected	High Z	I _{SB1} , I _{SB2}
L	H	H	Output disable	High Z	I _{CC1} , I _{CC2}
L	L	H	Read	Data out	I _{CC1} , I _{CC2}
L	X	L	Write	Data in	I _{CC1} , I _{CC2}

X : "H" or "L"

DC Recommended Operating Conditions

(Ta = 0 to + 70°C, GND = 0V)

Item	Symbol	Min.	Typ.	Max.	Unit
Supply voltage	V _{CC}	4.5	5.0	5.5	V
Input high voltage	V _{IH}	2.2	—	V _{CC} + 0.3	V
Input low voltage	V _{IL}	- 0.3*	—	0.8	V

* V_{IL} = - 3.0V Min. for pulse width less than 50ns.

Electrical Characteristics

• DC and operating characteristics

(V_{CC} = 5V ± 10%, GND = 0V, T_a = 0 to +70°C)

Item	Symbol	Test conditions	- 70L/10L/12L			- 70LL/10LL/12LL			Unit	
			Min.	Typ.*	Max.	Min.	Typ.*	Max.		
Input leakage current	I _{LI}	V _{IN} = GND to V _{CC}	-0.5	—	0.5	-0.5	—	0.5	μA	
Output leakage current	I _{LO}	$\overline{CE} = V_{IH}$ or $\overline{OE} = V_{IH}$ V _{I/O} = GND to V _{CC}	-0.5	—	0.5	-0.5	—	0.5	μA	
Operating power supply current	I _{CC1}	$\overline{CE} = V_{IL}$, V _{IN} = V _{IH} or V _{IL} , I _{OUT} = 0mA	—	3	10	—	3	10	mA	
		$\overline{CE} \leq 0.2V$ V _{IN} $\leq 0.2V$ or $\geq V_{CC} - 0.2V$	—	1	5	—	1	5		
Average operating current	I _{CC2}	Cycle = Min, Duty = 100%, I _{OUT} = 0mA	70L/70LL	—	30	50	—	30	50	mA
			10L/10LL	—	23	50	—	23	50	
			12L/12LL	—	20	50	—	20	50	
Standby current	I _{SB1}	$\overline{CE} \geq V_{CC} - 0.2V$	0 to 70°C	—	—	25	—	—	5	μA
			0 to 40°C	—	—	5	—	—	1	
			25°C	—	0.5	2	—	0.2	0.5	
	I _{SB2}	$\overline{CE} = V_{IH}$	—	0.4	2	—	0.4	2	mA	
Output high voltage	V _{OH}	I _{OH} = -1.0mA	2.4	—	—	2.4	—	—	V	
Output low voltage	V _{OL}	I _{OL} = 2.1mA	—	—	0.4	—	—	0.4	V	

* V_{CC} = 5V, T_a = 25°C

I/O capacitance

(T_a = 25°C, f = 1MHz)

Item	Symbol	Test conditions	Min.	Max.	Unit
Input capacitance	C _{IN}	V _{IN} = 0V	—	6	pF
I/O capacitance	C _{I/O}	V _{I/O} = 0V	—	8	pF

Note) This parameter is sampled and is not 100% tested.

AC characteristics**● AC test conditions**(V_{CC} = 5V ± 10%, T_a = 0 to +70°C)

Item		Conditions
Input pulse high level		V _{IH} = 2.2V
Input pulse low level		V _{IL} = 0.8V
Input rise time		t _r = 5ns
Input fall time		t _f = 5ns
Input and output reference level		1.5V
Output load conditions	10L/10LL/12L/12LL	C _L * = 100pF, 1TTL
	70L/70LL	C _L * = 30pF, 1TTL

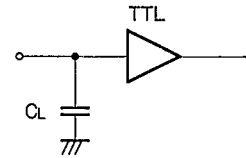
* C_L includes scope and jig capacitances.

• Read cycle

Item	Symbol	-70L/70LL		-10L/10LL		-12L/12LL		Unit
		Min.	Max.	Min.	Max.	Min.	Max.	
Read cycle time	t _{RC}	70	—	100	—	120	—	ns
Address access time	t _{AA}	—	70	—	100	—	120	ns
Chip enable access time	t _{CO}	—	70	—	100	—	120	ns
Output enable to output valid	t _{OE}	—	35	—	50	—	60	ns
Output hold from address change	t _{OH}	20	—	20	—	20	—	ns
Chip enable to output in low Z (\overline{CE})	t _{LZ}	10	—	10	—	10	—	ns
Output enable to output in low Z (\overline{OE})	t _{OLZ}	5	—	5	—	5	—	ns
Chip disable to output in high Z (\overline{CE})	t _{HZ} *	0	30	0	30	0	30	ns
Chip disable to output in high Z (\overline{OE})	t _{OHZ} *	0	30	0	30	0	30	ns

* t_{HZ} and t_{OHZ} are defined as the time required for outputs to turn to high impedance state and are not referred to as output voltage levels.

• Write cycle

Item	Symbol	-70L/70LL		-10L/10LL		-12L/12LL		Unit
		Min.	Max.	Min.	Max.	Min.	Max.	
Write cycle time	t _{WC}	70	—	100	—	120	—	ns
Address valid to end of write	t _{AW}	65	—	80	—	100	—	ns
Chip enable to end of write	t _{CW}	65	—	80	—	100	—	ns
Data to write time overlap	t _{DW}	30	—	35	—	40	—	ns
Data hold from write time	t _{DH}	0	—	0	—	0	—	ns
Write pulse width	t _{WP}	50	—	60	—	70	—	ns
Address setup time	t _{AS}	0	—	0	—	0	—	ns
Write recovery time (\overline{WE})	t _{WR}	0	—	0	—	0	—	ns
Write recovery time (\overline{CE})	t _{WR1}	0	—	0	—	0	—	ns
Output active from end of write	t _{OW}	10	—	10	—	10	—	ns
Write to output in high Z	t _{WHZ} *	0	25	0	25	0	25	ns

* t_{WHZ} is defined as the time required for outputs to turn to high impedance state and is not referred to as output voltage level.

Timing Waveform

- Read cycle (1) : $\overline{CE} = \overline{OE} = V_{IL}$, $\overline{WE} = V_{IH}$

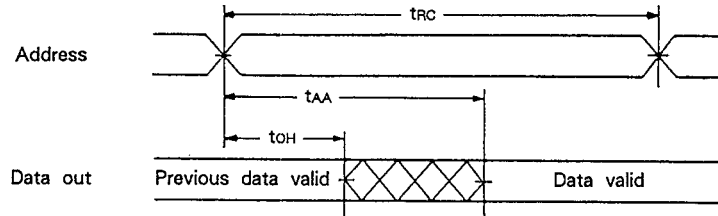

- Read cycle (2) : $\overline{WE} = V_{IH}$

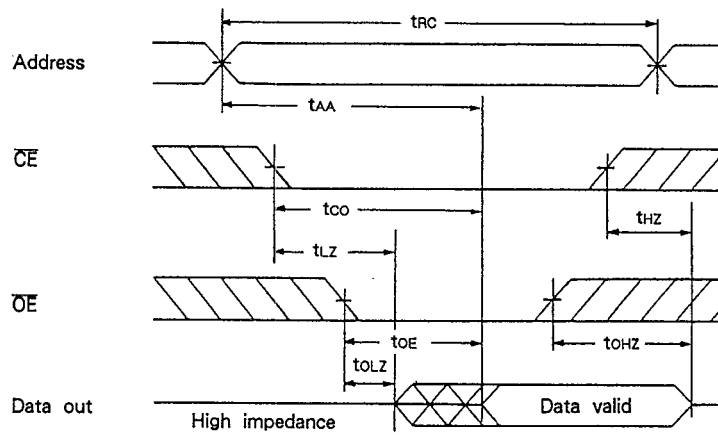

- Write cycle (1) : \overline{WE} control

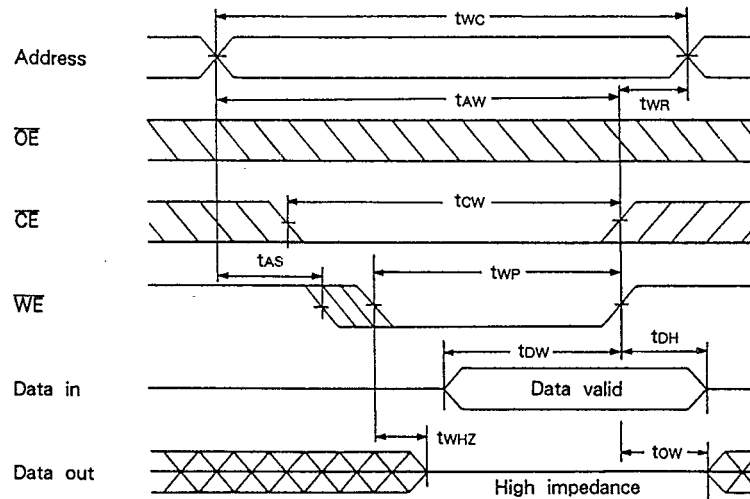

• Write cycle (2) : \overline{CE} control

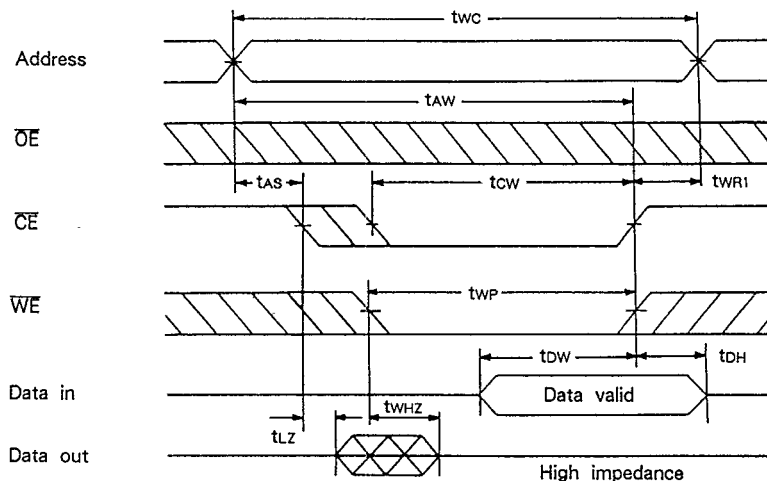

During I/O pins are in the output state, the data input signals of opposite phase to the output must not be applied.

Data Retention Characteristics

($T_a = 0$ to 70°C)

Item	Symbol	Test conditions	-70L/10L/12L			-70LL/10LL/12LL			Unit	
			Min.	Typ.	Max.	Min.	Typ.	Max.		
Data retention voltage	V_{DR}	$\overline{CE} \geq V_{CC} - 0.2V$	2.0	—	5.5	2.0	—	5.5	V	
Data retention current	I_{CCDR1}	$V_{CC} = 3.0V$ $\overline{CE} \geq 2.8V$	$T_a = 0$ to 70°C	—	—	10	—	—	3	μA
			$T_a = 0$ to 40°C	—	—	2	—	—	0.6	
			25°C	—	0.25	1	—	0.1	0.3	
	I_{CCDR2}	$V_{CC} = 2.0$ to $5.5V$ $\overline{CE} \geq V_{CC} - 0.2V$	—	0.5	25	—	0.2	5	μA	
Data retention setup time	t_{CDRS}	Chip disable to data retention mode	0	—	—	0	—	—	ns	
Recovery time	t_R		t_{RC}^*	—	—	t_{RC}^*	—	—	ns	

* t_{RC} : Read cycle time

Data retention waveform

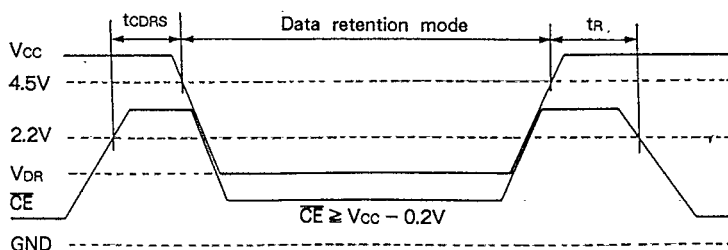

Example of Representative Characteristics

Supply current vs. Supply voltage

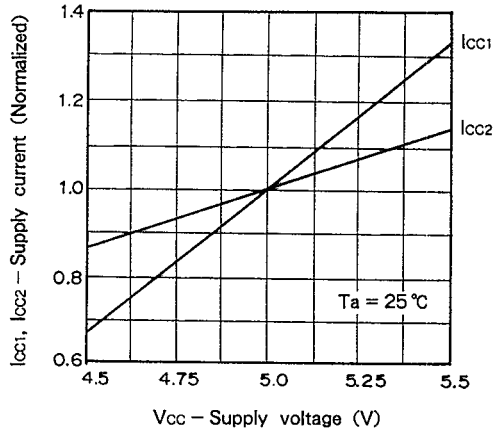

Supply current vs. Ambient temperature

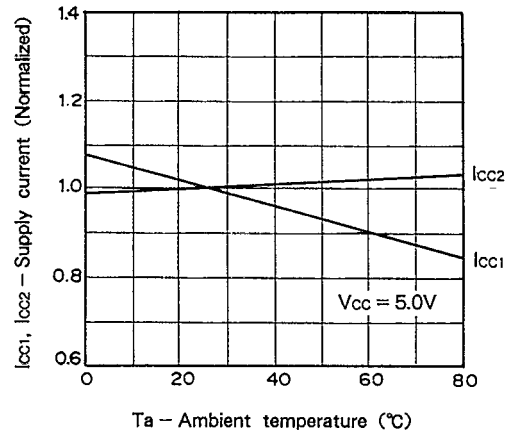

Supply current vs. Frequency

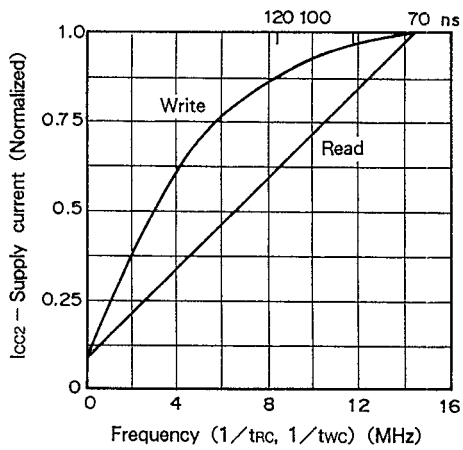

Access time vs. Load capacitance

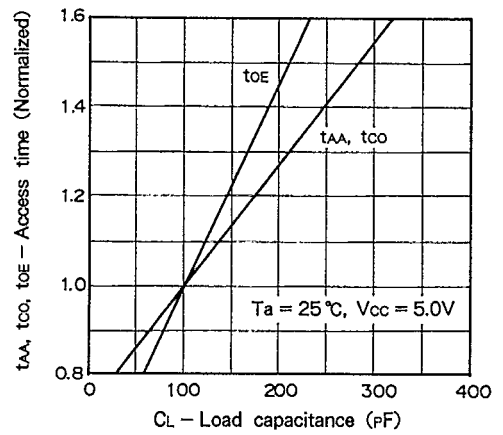

Access time vs. Supply voltage

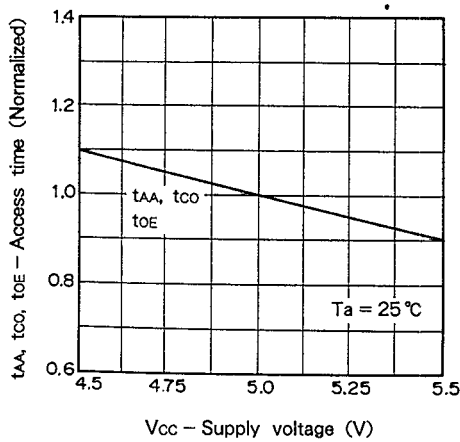

Access time vs. Ambient temperature

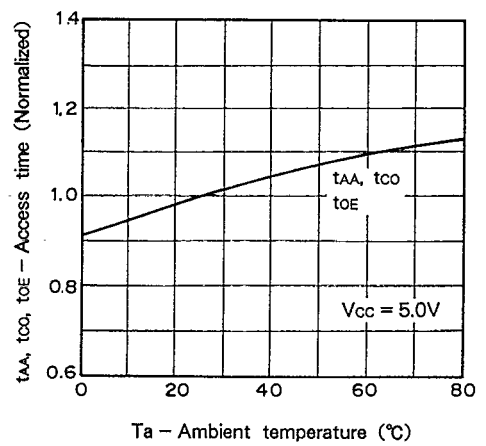

Standby current vs. Supply voltage

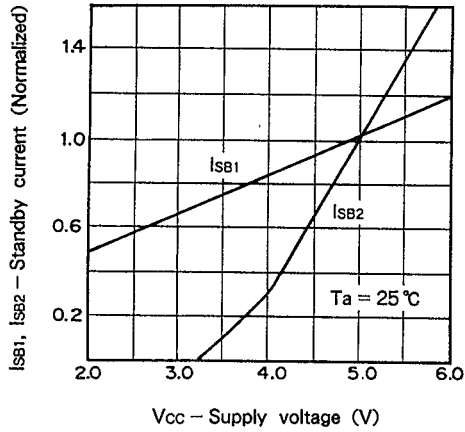

Standby current vs. Ambient temperature

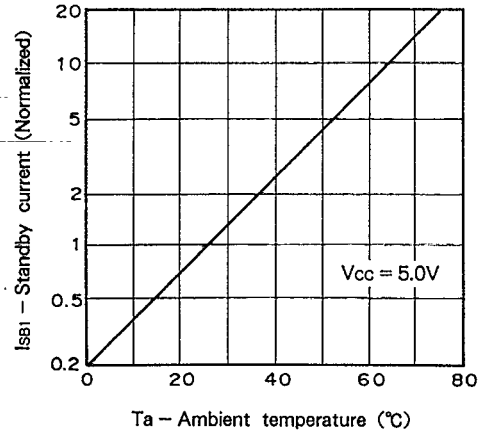

Input voltage level vs. Supply voltage

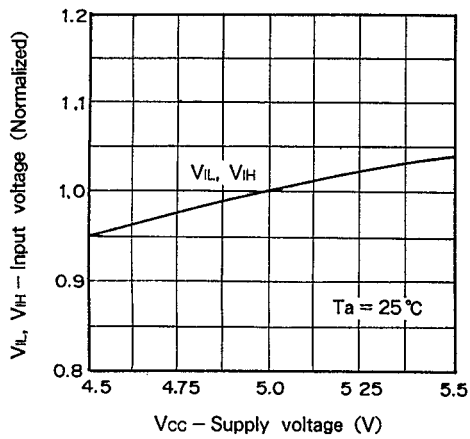

Standby current vs. Ambient temperature

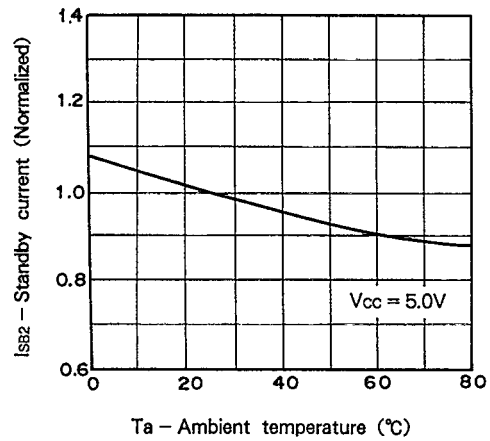

Output high current vs. Output high voltage

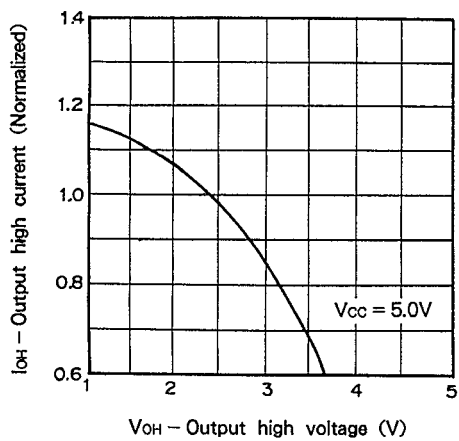

Output low current vs. Output low voltage

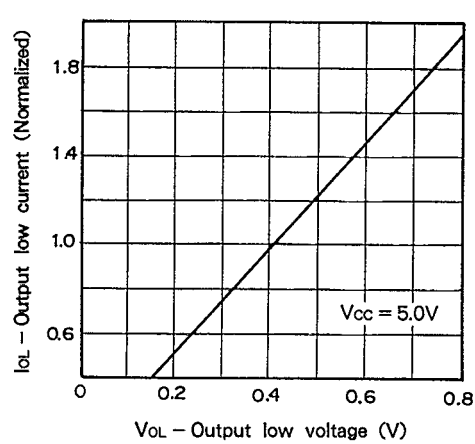

Package Outline Unit : mm

CXK58257AP 28pin DIP (Plastic) 600mil 4.2g

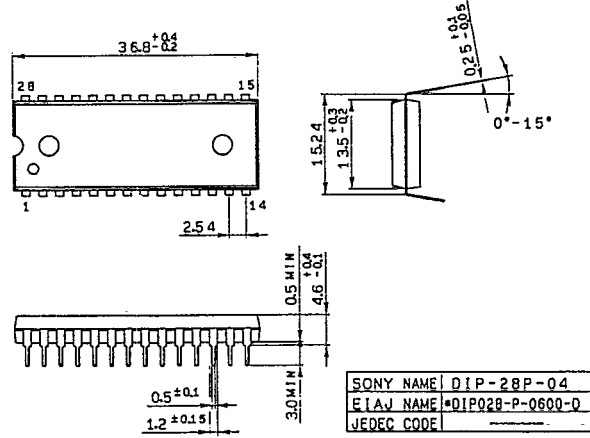

CXK58257ASP 28pin DIP (Plastic) 300mil 2.0g

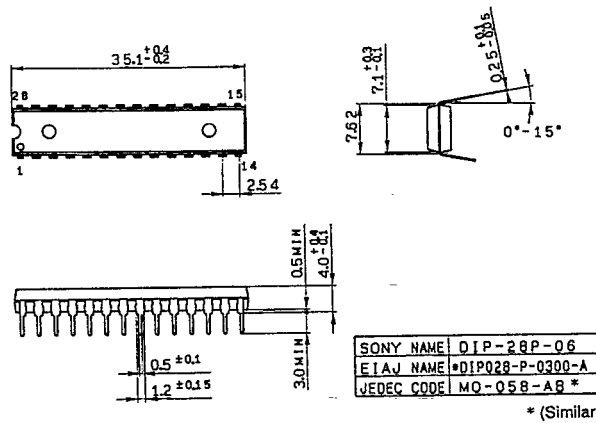

CXK58257AM 28pin SOP (Plastic) 450mil 0.7g

