

# HM628128 Series

---

## 131072-word × 8-bit High Speed CMOS Static RAM

The Hitachi HM628128 is a CMOS static RAM organized 128-kword × 8-bit. It realizes higher density, higher performance and low power consumption by employing 0.8  $\mu\text{m}$  Hi-CMOS process technology.

It offers low power standby power dissipation; therefore, it is suitable for battery back-up systems. The device, packaged in a 525-mil SOP (460-mil body SOP) or a 600-mil plastic DIP, or a 8 × 20 mm TSOP with thickness of 1.2 mm, is available for high density mounting. The TSOP package is suitable for cards, and reverse type TSOP is also provided.

### Features

- High speed: fast access time 70/85/100/120 ns (max)
- Low power
  - Standby: 10  $\mu\text{W}$  (typ) (L/L-L/L-SL version)
  - Operation: 75 mW (typ)
- Single 5 V supply
- Completely static memory
  - No clock or timing strobe required
- Equal access and cycle times
- Common data input and output: Three state output
- Directly TTL compatible: All inputs and outputs
- Capability of battery back up operation (L/L-L/L-SL version) (2 chip selection for battery back up)

# HM628128 Series

## Ordering Information

Type No.	Access time	Package	Type No.	Access time	Package
HM628128P-7	70 ns	600-mil, 32-pin plastic DIP (DP-32)	HM628128FP-7	70 ns	525 mil, 32-pin plastic SOP (FP-32D)
HM628128P-8	85 ns				
HM628128P-10	100 ns				
HM628128P-12	120 ns				
HM628128LP-7	70 ns		HM628128LFP-7	70 ns	
HM628128LP-8	85 ns				
HM628128LP-10	100 ns				
HM628128LP-12	120 ns				
HM628128LP-7SL	70 ns		HM628128LFP-7SL	70 ns	
HM628128LP-8SL	85 ns				
HM628128LP-10SL	100 ns				
HM628128LP-12SL	120 ns				
HM628128T-7	70 ns	8mm x 20mm 32-pin TSOP (normal type) (TFP-32D)	HM628128R-7	70 ns	8mm x 20 mm 32-pin TSOP (reverse type) (TFP-32DR)
HM628128T-8	85 ns				
HM628128T-10	100 ns				
HM628128T-12	120 ns				
HM628128LT-7	70 ns		HM628128LR-7	70 ns	
HM628128LT-8	85 ns				
HM628128LT-10	100 ns				
HM628128LT-12	120 ns				
HM628128LT-7L	70 ns		HM628128LR-7L	70 ns	
HM628128LT-8L	85 ns				
HM628128LT-10L	100 ns				
HM628128LT-12L	120 ns				
HM628128LT-7SL	70 ns		HM628128LR-7SL	70 ns	
HM628128LT-8SL	85 ns				
HM628128LT-10SL	100 ns				
HM628128LT-12SL	120 ns				

## Pin Arrangement

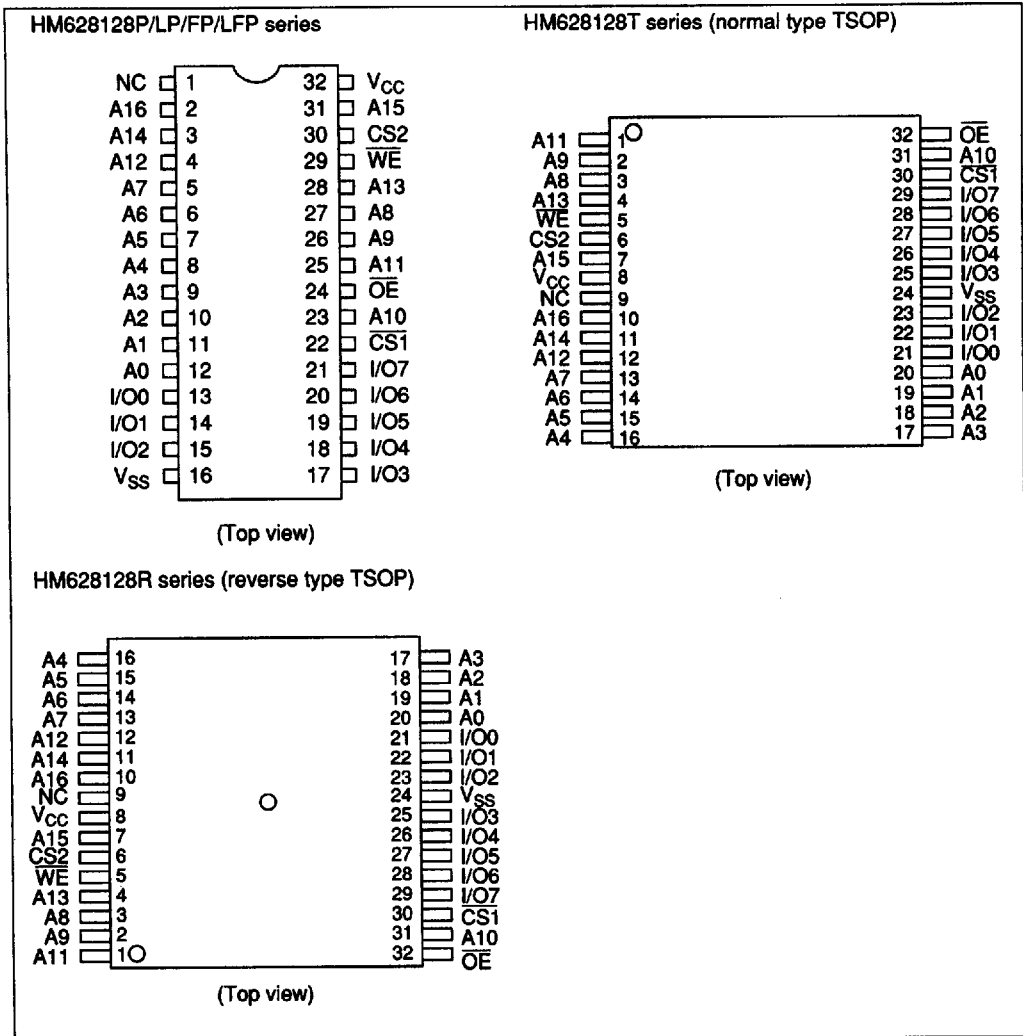

## Pin Description

Pin name	Function	Pin name	Function
A0-A16	Address	OE	Output enable
I/O0-I/O7	Input/output	NC	Not connected
CS1	Chip select 1	V <sub>CC</sub>	Power supply
CS2	Chip select 2	V <sub>SS</sub>	Ground
WE	Write enable		

# HM628128 Series

## Block Diagram

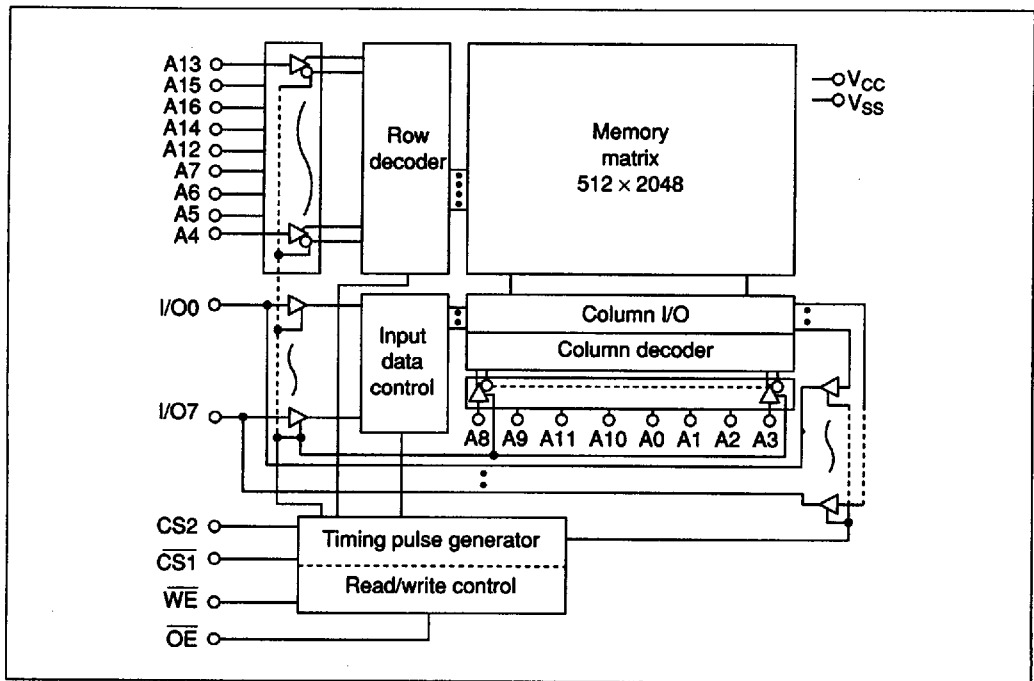

### Truth Table

$\overline{WE}$	$\overline{CS1}$	CS2	$\overline{OE}$	Mode	$V_{CC}$ current	Dout pin	Cycle
x	H	x	x	Not selected	$I_{SB}, I_{SB1}$	High-Z	—
x	x	L	x		$I_{SB}, I_{SB1}$	High-Z	—
H	L	H	H	Output disable	$I_{CC}$	High-Z	—
H	L	H	L	Read	$I_{CC}$	Dout	Read cycle
L	L	H	H	Write	$I_{CC}$	$D_{IN}$	Write cycle (1)
L	L	H	L		$I_{CC}$	$D_{IN}$	Write cycle (2)

Note: x: H or L

**Absolute Maximum Ratings**

Parameter	Symbol	Value	Unit
Voltage on any pin relative to V <sub>SS</sub>	V <sub>T</sub>	-0.5* to +7.0	V
Power dissipation	P <sub>T</sub>	1.0	W
Operating temperature	Topr	0 to +70	°C
Storage temperature	Tstg	-55 to +125	°C
Storage temperature under bias	Tbias	-10 to +85	°C

Note: -3.0 V for pulse half-width ≤ 30 ns

**Recommended DC Operating Conditions (Ta = 0 to +70°C)**

Parameter	Symbol	Min	Typ	Max	Unit
Supply voltage	V <sub>CC</sub>	4.5	5.0	5.5	V
	V <sub>SS</sub>	0	0	0	V
Input high (logic 1) voltage	V <sub>IH</sub>	2.2	--	6.0	V
Input low (logic 0) voltage	V <sub>IL</sub>	-0.3*	--	0.8	V

Note: -3.0 V for pulse half-width ≤ 30 ns

## HM628128 Series

DC Characteristics ( $T_a = 0$  to  $+70^\circ\text{C}$ ,  $V_{CC} = 5\text{ V} \pm 10\%$ ,  $V_{SS} = 0\text{ V}$ )

Parameter	Symbol	Min	Typ <sup>1</sup>	Max	Unit	Test conditions
Input leakage current	$ I_{LI} $	—	—	2	$\mu\text{A}$	$V_{IN} = V_{SS}$ to $V_{CC}$
Output leakage current	$ I_{LO} $	—	—	2	$\mu\text{A}$	$\overline{CS1} = V_{IH}$ or $CS2 = V_{IL}$ or $OE = V_{IH}$ or $WE = V_{IL}$ , $V_{IO} = V_{SS}$ to $V_{CC}$
Operating power supply current: DC	$I_{CC}$	—	15	35	mA	$\overline{CS1} = V_{IL}$ , $CS2 = V_{IH}$ , others = $V_{IH}/V_{IL}$ , $I_{VO} = 0$ mA
Operating power supply current	$I_{CC1}$	—	45	70	mA	Min. cycle, duty = 100%, $\overline{CS1} = V_{IL}$ , $CS2 = V_{IH}$ , others = $V_{IH}/V_{IL}$ $I_{VO} = 0$ mA
	$I_{CC2}$	—	15	30	mA	Cycle time = 1 $\mu\text{s}$ , duty = 100%, $I_{VO} = 0$ mA, $\overline{CS1} \leq 0.2\text{ V}$ , $CS2 \geq V_{CC} - 0.2\text{ V}$ , $V_{IH} \geq V_{CC} - 0.2\text{ V}$ , $V_{IL} \leq 0.2\text{ V}$
Standby power supply current: DC	$I_{SB}$	—	1	3	mA	$\overline{CS1} = V_{IH}$ , $CS2 = V_{IH}$ or $CS2 = V_{IL}$
Standby power supply current (1): DC	$I_{SB1}$	—	0.02	2	mA	$V_{IN} \geq 0\text{ V}$ , $\overline{CS1} \geq V_{CC} - 0.2\text{ V}$ , $CS2 \geq V_{CC} - 0.2\text{ V}$ or $0\text{ V} \leq CS2 \leq CS2 = V_{IL}$
		—	$2^2$	$100^2$	$\mu\text{A}$	
		—	$2^3$	$50^3$	$\mu\text{A}$	
Output low voltage	$V_{OL}$	—	—	0.4	V	$I_{OL} = 2.1\text{ mA}$
Output high voltage	$V_{OH}$	2.4	—	—	V	$I_{OH} = -1.0\text{ mA}$

- Note: 1. Typical values are at  $V_{CC} = 5.0\text{ V}$ ,  $T_a = +25^\circ\text{C}$  and specified loading.  
2. These characteristics are guaranteed only for L-version.  
3. These characteristics are guaranteed only for L-L/L-SL version.

## Capacitance ( $T_a = 25^\circ\text{C}$ , $f = 1.0\text{ MHz}$ )

Parameter	Symbol	Min	Typ	Max	Unit	Test conditions
Input capacitance	$C_{in}$	—	—	8	pF	$V_{IN} = 0\text{ V}$
Input/output capacitance	$C_{IO}$	—	—	10	pF	$V_{IO} = 0\text{ V}$

Note: These parameters are sampled and not 100% tested.

## AC Characteristics (Ta = 0 to +70°C, V<sub>CC</sub> = 5 V ± 10%, unless otherwise noted)

### Test Conditions:

- Input pulse levels: 0.8 V to 2.4 V
- Input and output timing reference: 1.5 V
- Input rise and fall times: 5 ns
- Output load: 1 TTL gate and C<sub>L</sub> (100 pF) (Including scope and jig)

### Read Cycle

Parameter	Symbol	HM628128-7		HM628128-8		HM628128-10		HM628128-12		Unit
		Min	Max	Min	Max	Min	Max	Min	Max	
Read cycle time	t <sub>RC</sub>	70	—	85	—	100	—	120	—	ns
Address access time	t <sub>AA</sub>	—	70	—	85	—	100	—	120	ns
Chip selection (CS1) to output valid	t <sub>CO1</sub>	—	70	—	85	—	100	—	120	ns
Chip selection (CS2) to output valid	t <sub>CO2</sub>	—	70	—	85	—	100	—	120	ns
Output enable (OE) output valid	t <sub>OE</sub>	—	35	—	45	—	50	—	60	ns
Chip selection (CS1) to output in low-Z <sup>1,2,3</sup>	t <sub>LZ1</sub>	10	—	10	—	10	—	10	—	ns
Chip selection (CS2) to output in low-Z <sup>1,2,3</sup>	t <sub>LZ2</sub>	10	—	10	—	10	—	10	—	ns
Output enable (OE) to output in low-Z <sup>1,2,3</sup>	t <sub>OLZ</sub>	5	—	5	—	5	—	5	—	ns
Chip deselection (CS1) to output in high-Z <sup>1,2,3</sup>	t <sub>HZ1</sub>	0	25	0	30	0	35	0	45	ns
Chip deselection (CS2) to output in high-Z <sup>1,2,3</sup>	t <sub>HZ2</sub>	0	25	0	30	0	35	0	45	ns
Output disable (OE) to output in high-Z <sup>1,2,3</sup>	t <sub>OHZ</sub>	0	25	0	30	0	35	0	45	ns
Output hold from address change	t <sub>OH</sub>	10	—	10	—	10	—	10	—	ns

- Notes: 1. t<sub>HZ</sub> and t<sub>OHZ</sub> are defined as the time at which the outputs achieve the open circuit conditions and are not referred to output voltage levels.
2. At any given temperature and voltage condition, t<sub>HZ</sub> max is less than t<sub>LZ</sub> min both for a given device and from device to device.
3. These parameters are sampled and not 100% tested.

4496203 0024979 736

**HITACHI**

Hitachi America, Ltd. • Hitachi Plaza • 2000 Sierra Point Pkwy. • Brisbane, CA 94005-1819 • (415) 589-8300

5

# HM628128 Series

## Read Timing Waveform

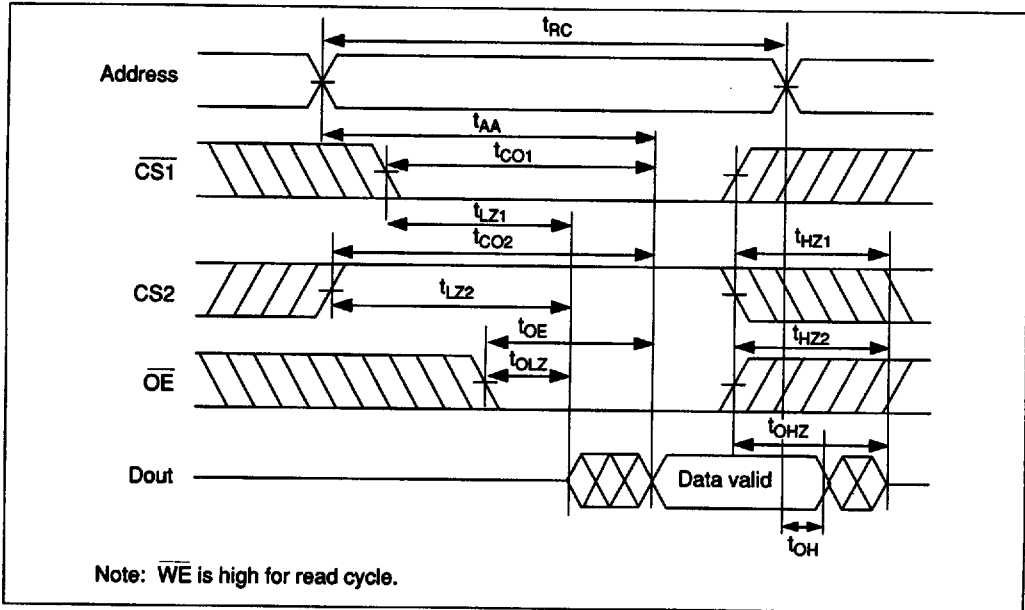

## Write Cycle

Parameter	Symbol	HM628128-7		HM628128-8		HM628128-10		HM628128-12		Unit
		Min	Max	Min	Max	Min	Max	Min	Max	
Write cycle time	$t_{WC}$	70	—	85	—	100	—	120	—	ns
Chip selection to end of write	$t_{CW}$	60	—	75	—	80	—	85	—	ns
Address setup time	$t_{AS}$	0	—	0	—	0	—	0	—	ns
Address valid to end of write	$t_{AW}$	60	—	75	—	80	—	85	—	ns
Write pulse width	$t_{WP}$	50	—	55	—	60	—	70	—	ns
Write recovery time <sup>*1</sup>	$t_{WR}$	5	—	5	—	5	—	10	—	ns
		10	—	10	—	10	—	15	—	ns <sup>*1</sup>
Write to output in high-Z <sup>2</sup>	$t_{WHZ}$	0	25	0	30	0	35	0	40	ns
Data to write time overlap	$t_{DW}$	30	—	35	—	40	—	45	—	ns
Write hold from write time	$t_{DH}$	0	—	0	—	0	—	0	—	ns
Output active from end of write <sup>*1</sup>	$t_{OW}$	5	—	5	—	5	—	5	—	ns

Notes: 1. This value is measured from CS2 going low to the end of write cycle.  
2. This parameter is sampled and not 100% tested.



Write Timing Waveform (1) ( $\overline{OE}$  Clock)

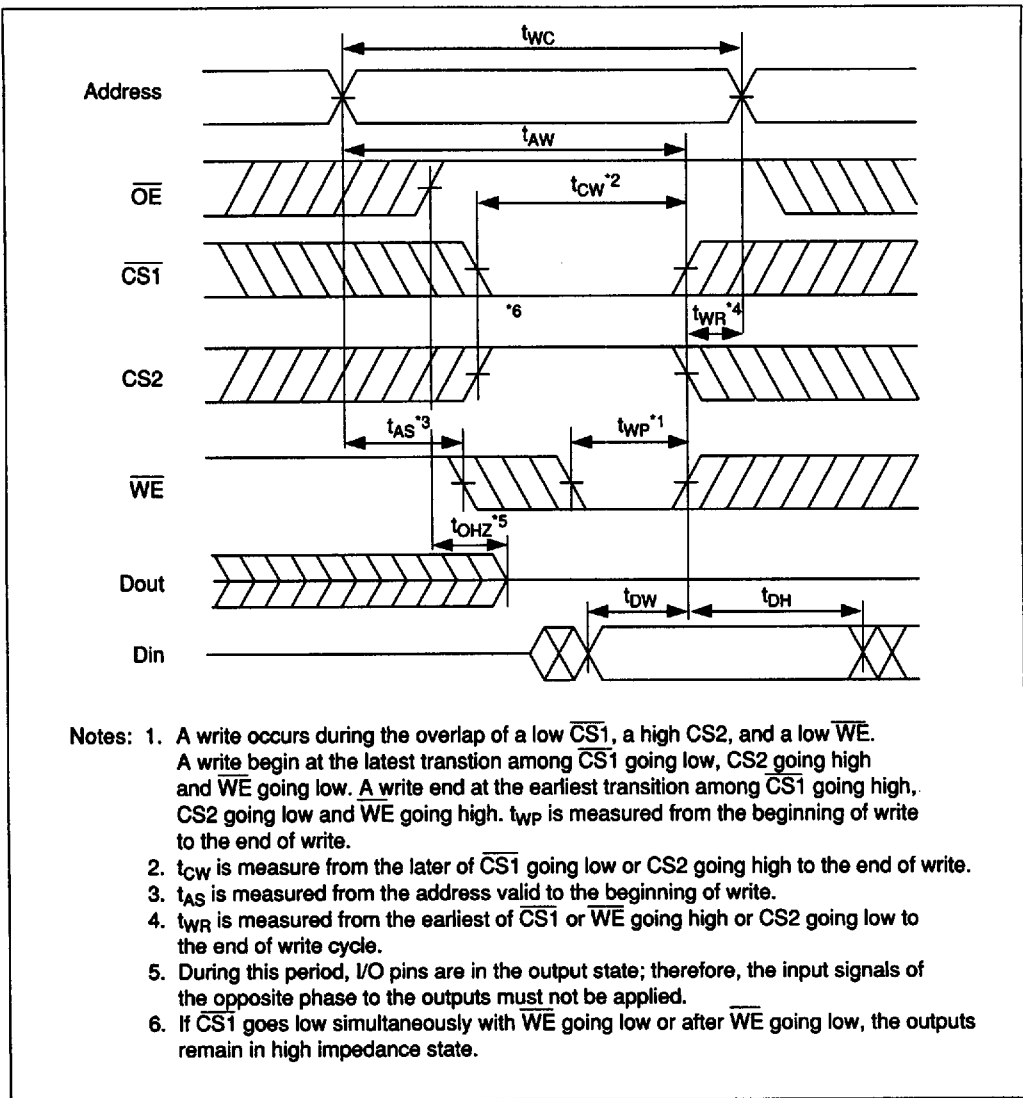

5

# HM628128 Series

## Write Timing Waveform (2) ( $\overline{OE}$ Fixed Low)

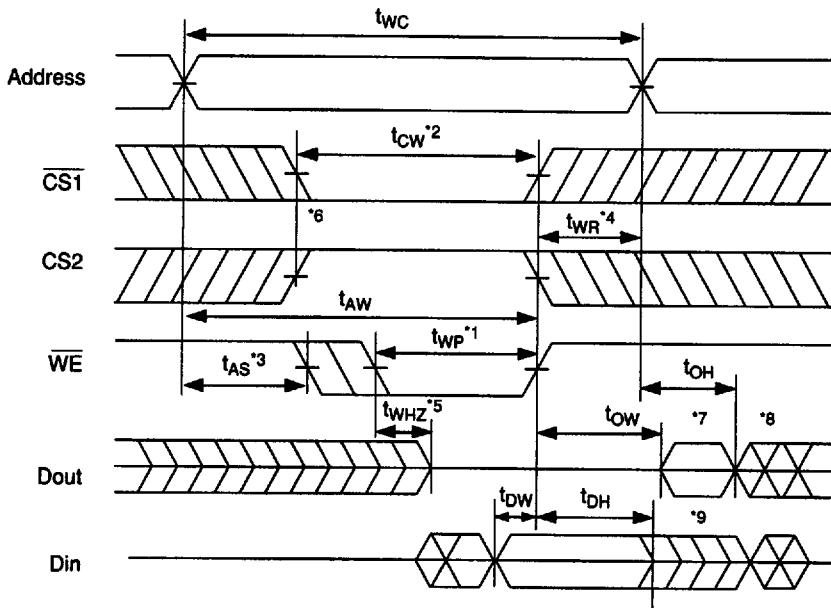

- Notes:
1. A write occurs during the overlap of a low  $\overline{CS1}$ , a high  $CS2$ , and a low  $\overline{WE}$ . A write begins at the latest transition among  $\overline{CS1}$  going low,  $CS2$  going high and  $\overline{WE}$  going low. A write ends at the earliest transition among  $\overline{CS1}$  going high,  $CS2$  going low and  $\overline{WE}$  going high.  $t_{WP}$  is measured from the beginning of write to the end of write.  $t_{WP}$  must satisfy the following equation to avoid a problem of data bus contention.  $t_{WP} \geq t_{DOW} \text{ min} + t_{WHZ} \text{ max}$
  2.  $t_{CW}$  is measure from the later of  $\overline{CS1}$  going low or  $CS2$  going high to the end of write.
  3.  $t_{AS}$  is measured from the address valid to the beginning of write.
  4.  $t_{WR}$  is measured from the earliest of  $\overline{CS1}$  or  $\overline{WE}$  going high or  $CS2$  going low to the end of write cycle.
  5. During this period, I/O pins are in the output state; therefore, the input signals of the opposite phase to the outputs must not be applied.
  6. If  $\overline{CS1}$  goes low simultaneously with  $\overline{WE}$  going low or after  $\overline{WE}$  going low, the outputs remain in high impedance state.
  7.  $Dout$  is the same phase of the latest written data in this write cycle.
  8.  $Dout$  is the read data of next address.
  9. If  $\overline{CS1}$  is low and  $CS2$  is high during this period, I/O pins are in the output state. Therefore, the input signals of the opposite phase to the outputs must not be applied to them.

Low  $V_{CC}$  Data Retention Characteristics ( $T_a = 0$  to  $+70^\circ\text{C}$ )

(These characteristics are guaranteed only for L, L-L, and L-SL version.)

Parameter	Symbol	Min	Typ	Max	Unit	Test conditions <sup>*4</sup>	
$V_{CC}$ for data retention	$V_{DR}$	2.0	—	—	V	$\overline{CS1} \geq V_{CC} - 0.2\text{V}$ , $CS2 \geq V_{CC} - 0.2\text{V}$ , or $0\text{V} \leq CS2 \leq 0.2\text{V}$ , $V_{in} \geq$	
Data retention current	$I_{CCDR}$	L	—	1	$50^{*1}$	$\mu\text{A}$	$V_{CC} = 3.0\text{V}$ , $V_{in} \geq 0\text{V}$ , $\overline{CS1} \geq V_{CC} - 0.2\text{V}$ , $CS2 \geq V_{CC} - 0.2\text{V}$ , or $0\text{V} \leq CS2 \leq 0.2\text{V}$
		L-L	—	1	$30^{*2}$	$\mu\text{A}$	
		L-SL	—	1	$15^{*3}$	$\mu\text{A}$	
Chip deselect to data retention time	$t_{CDR}$	0	—	—	ns	See retention waveform	
Operation recovery time	$t_R$	5	—	—	ms		

- Notes: 1.  $20\ \mu\text{A}$  max at  $T_a = 0$  to  $40^\circ\text{C}$   
 2.  $6\ \mu\text{A}$  max at  $T_a = 0$  to  $40^\circ\text{C}$   
 3.  $3\ \mu\text{A}$  max at  $T_a = 0$  to  $40^\circ\text{C}$   
 4.  $CS2$  controls address buffer,  $\overline{WE}$  buffer,  $\overline{CS1}$  buffer,  $\overline{OE}$  buffer, and  $Din$  buffer. If  $CS2$  controls data retention mode,  $V_{in}$  levels (address,  $\overline{WE}$ ,  $\overline{OE}$ ,  $\overline{CS1}$ , I/O) can be in the high impedance state. If  $CS1$  controls data retention mode,  $CS2$  must be  $CS2 \geq V_{CC} - 0.2\text{V}$  or  $0\text{V} \leq CS2 \leq 0.2\text{V}$ . The other input levels (address,  $\overline{WE}$ ,  $\overline{OE}$ , I/O) can be in the high impedance state.

Low  $V_{CC}$  Data Retention Timing Waveform (1) ( $\overline{CS1}$  Controlled)

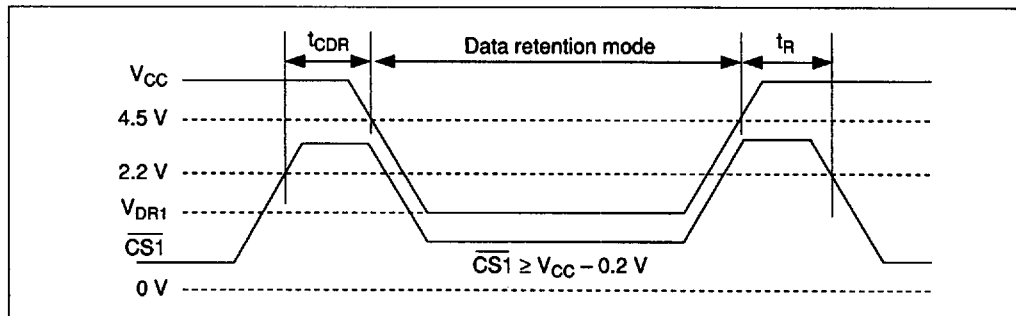

Low  $V_{CC}$  Data Retention Timing Waveform (2) ( $CS2$  Controlled)

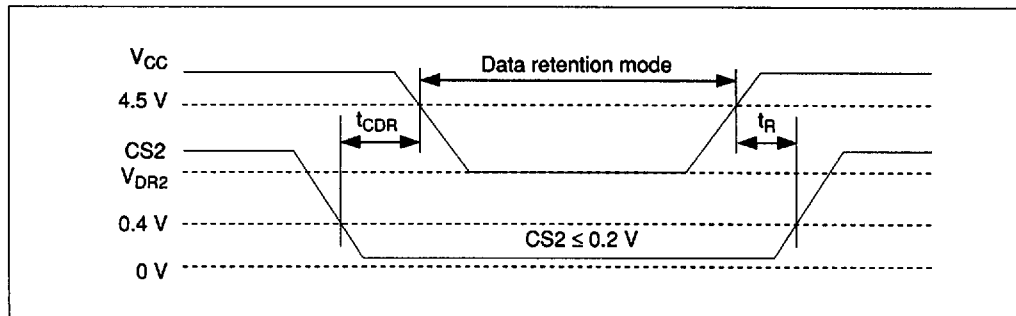

5

4496203 0024963 167

HITACHI

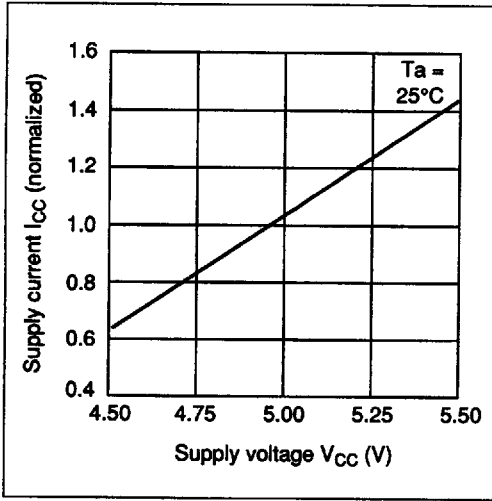

**Supply Current vs. Supply Voltage (1)**

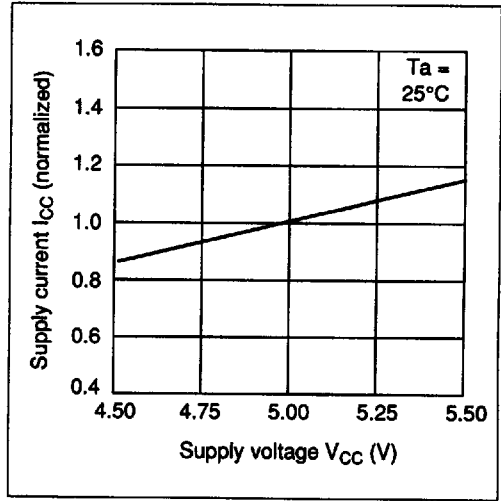

**Supply Current vs. Supply Voltage (2)**

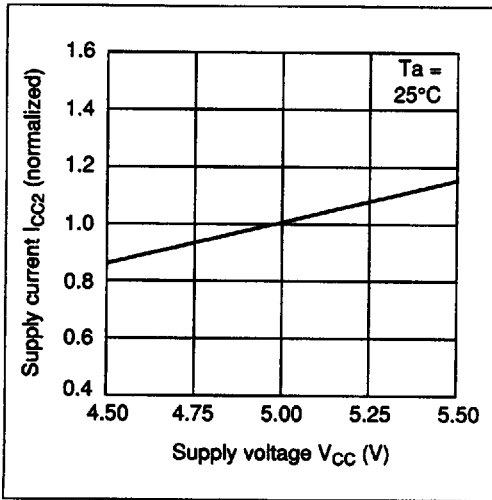

**Supply Current vs. Supply Voltage (3)**

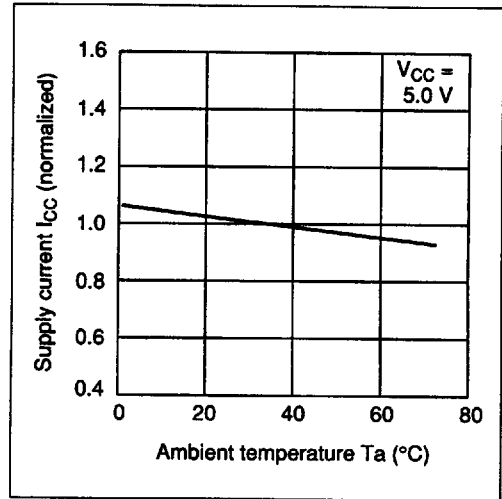

**Supply Current vs. Ambient Temperature (1)**

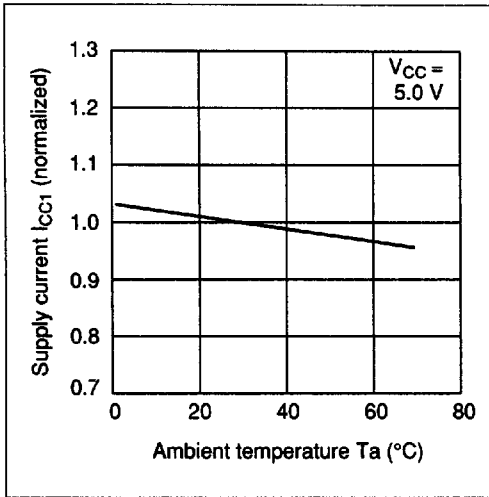

Supply Current vs. Ambient Temperature (2)

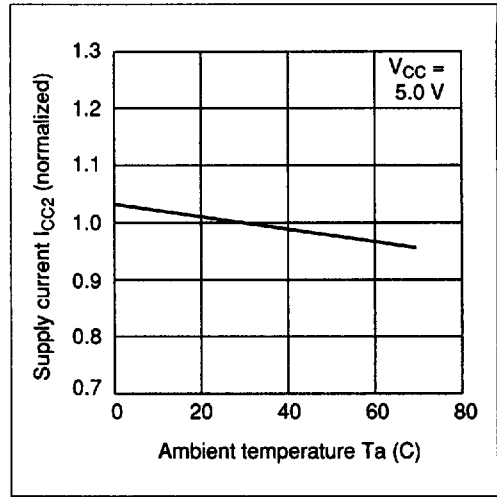

Supply Current vs. Ambient Temperature (3)

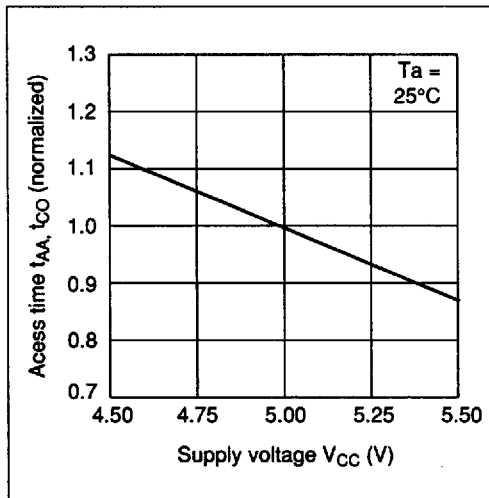

Access Time vs. Supply Voltage

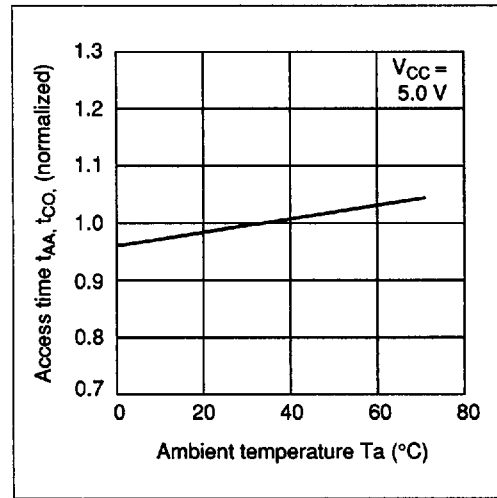

Access Time vs. Ambient Temperature

5

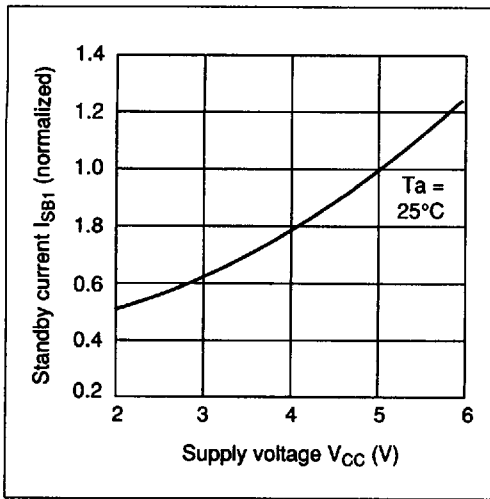

Standby Current vs. Supply Voltage

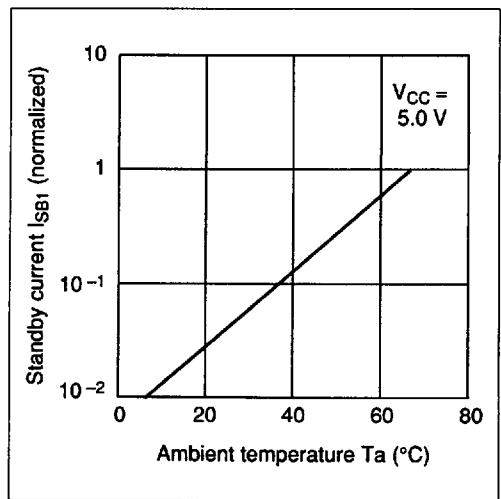

Standby Current vs. Ambient Temperature

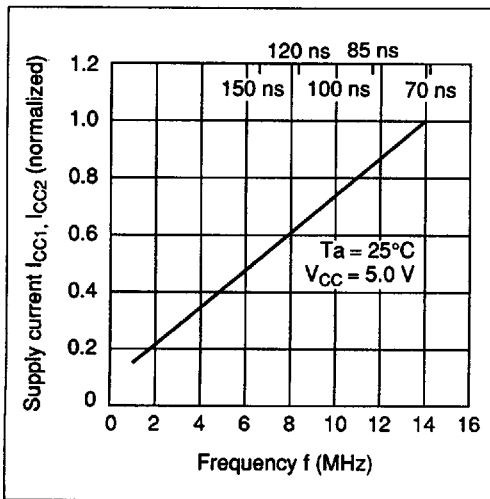

Supply Current vs. Frequency (Read)

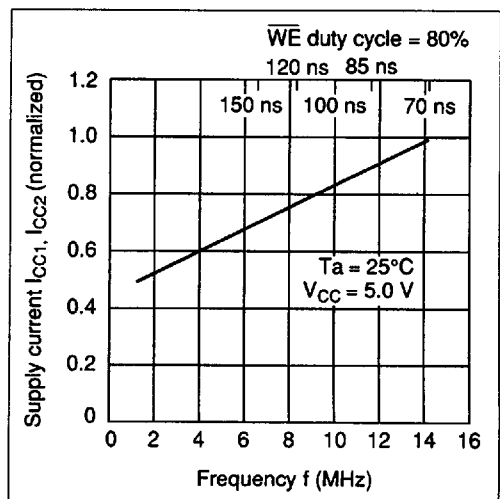

Supply Current vs. Frequency (Write)

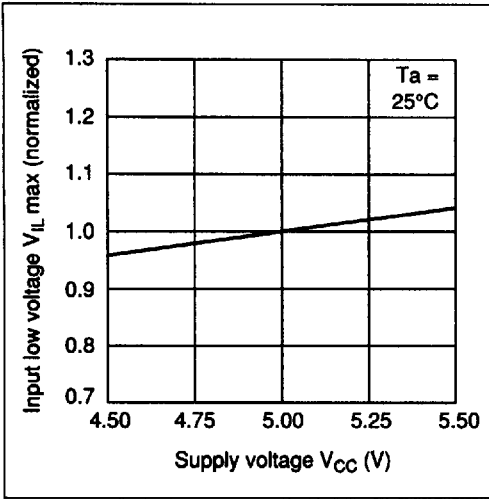

Input Low Voltage vs. Supply Voltage

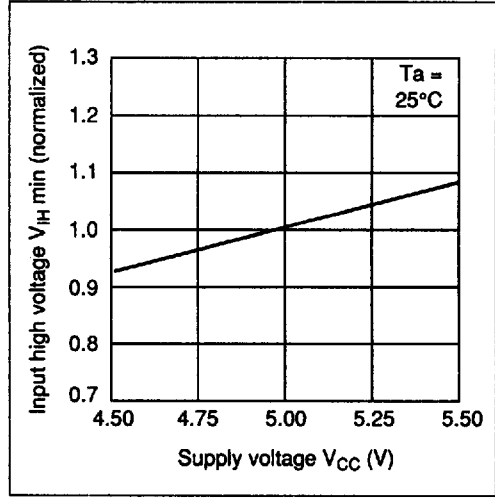

Input High Voltage vs. Supply Voltage

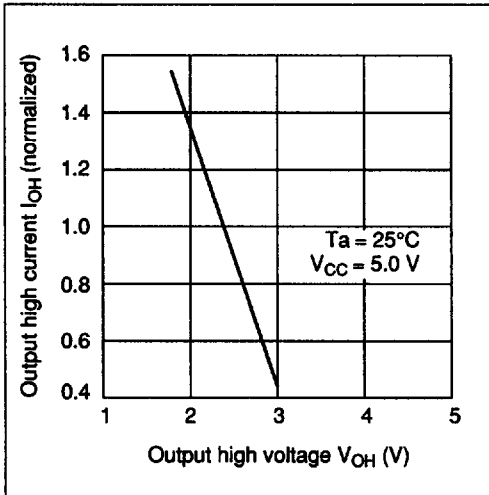

Output High Current vs. Output High Voltage

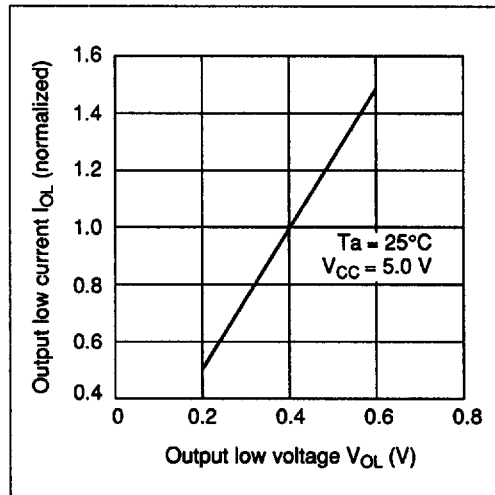

Output Low Current vs. Output Low Voltage

5

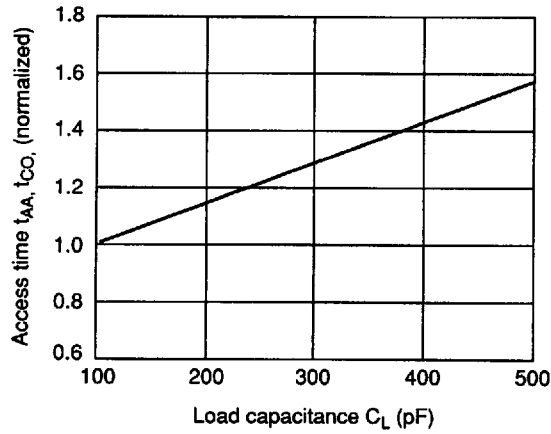

Access Time vs. Load Capacitance